

**P R O
D U C
T S .
C A T
A L O
G U E**



B&B DENTAL
IMPLANT COMPANY





B&B

INDEX

01.

B&B DENTAL

COMPANY INTRODUCTION.....	4
SUPPORT & DEVELOPMENT.....	5
PRODUCTION.....	7
B&B DENTAL IMPLANT LINES.....	8
PACKAGING.....	9
TIGHTENING INSTRUCTIONS.....	11
KEYS & DRIVERS TIGHTENING.....	12

02.

CONEXA IMPLANTS

CONEXA IMPLANTS.....	13
CONEXA CONNECTION.....	15
DURA-VIT EV LINE.....	17
DURA-VIT 3P LINE.....	19
DURA-VIT WIDE LINE.....	21
DURA-VIT PTERYGO LINE.....	23
HEALING COMPONENTS.....	25
COMPONENTS FOR IMPRESSIONS.....	26
TEMPORARY PROSTHETIC COMPONENTS	
TRY-INN ABUTMENTS.....	27
TEMPORARY ABUTMENTS IN PEEK.....	28
TEMPORARY ABUTMENTS IN TITANIUM.....	29
DEFINITIVE PROSTHETIC COMPONENTS	
UCLA ABUTMENTS.....	30
STRAIGHT TITANIUM ABUTMENTS.....	31
ANGLED TITANIUM ABUTMENTS.....	32
DIGITAL COMPONENTS.....	33
MULTI USE ABUTMENTS.....	35
DIGITAL COMPONENTS FOR MUA.....	38
CONICAL SYSTEM.....	39
FLAT ANCHORING SYSTEM.....	41
DIGITAL COMPONENTS FOR FLAT.....	42
SPHERICAL ANCHORING SYSTEM.....	43

03.

REDUCED DIAMETER IMPLANTS

REDUCED DIAMETER IMPLANTS.....	46
DURA-VIT SLIM LINE.....	47
IMPRESSION AND HEALING COMPONENTS.....	49
PROSTHETIC COMPONENTS	
TITANIUM ABUTMENTS.....	50
TEMPORARY AND CASTABLE ABUTMENTS.....	51

04.

DIGITAL COMPONENTS.....	52
FLAT ANCHORING SYSTEM.....	53
DIGITAL COMPONENTS FOR FLAT	54
SPHERICAL ANCHORING SYSTEM.....	55

MINI IMPLANTS

MINI IMPLANTS.....	57
DURA-VIT MINI LINE (SPHERICAL-SQUARE).....	59
PROSTHETIC COMPONENTS	61
SPHERICAL HEAD	
SQUARE HEAD	

05.

SURGICAL INSTRUMENTS & KITS

SURGICAL INSTRUMENTS & KITS	63
COMPLETE SURGICAL KIT.....	65
SIMPLIFIED SURGICAL KIT.....	67
PTERYGO SURGICAL KIT	69
CRESTAL SINUS LIFT KIT	71
WIDE SURGICAL KIT.....	73
PROSTHETIC KIT	74
MINI IMPLANTS KIT	75
SURGICAL COMPONENTS.....	76
SURGICAL PROTOCOLS	
3P DRILLING PROCEDURE (D1-D2).....	85
3P DRILLING PROCEDURE (D3-D4).....	86
EV DRILLING PROCEDURE (D1- D2-D3-D4).....	87
WIDE-SLIM DRILLING PROCEDURE	88
PTERYGO DRILLING PROCEDURE	89
MINI DRILLING PROCEDURE	90
TRANSCRESTAL SINUS LIFT PROCEDURE	91
SMARTPEG OSSTELL.....	91
PHYSIO BRUSHLESS 3000	92
T-BARRIER COLLAGEN-TITANIUM	93

06.

DIGITAL WORKFLOW

DIGITAL WORKFLOW.....	95
GUIDED SURGERY TOOLS.....	96
OFFSET +2+4 KIT.....	97
GUIDED SLEEVES.....	98
MATCHING WITH RADIOPAQUE MARKERS.....	98
SURGICAL PROTOCOLS.....	99
GUIDED SURGERY KIT + DRILLS.....	101
GUIDED SURGERY PROTOCOLS.....	102
SYNERGY.....	103





01.

B&B DENTAL

COMPANY INTRODUCTION



B&B Dental srl is an Italian leading company in the oral implantology sector. It specialises in designing and manufacturing dental implants and bone regeneration materials. The Dura-vit implant line is born out of constant innovation and makes use of excellent raw materials.

Quality and passion are the hallmarks of B&B Dental. The product range is designed by dentists for dentists, in collaboration with our experienced implant engineers.



SUPPORT & DEVELOPMENT



RESEARCH & DEVELOPMENT

The multi-year experience in the industry not only ensures assessment and innovation of design and functionality of our products and materials, but also allows us to offer practitioners a wider range of products, all studied in-depth and tested in house, but we do even more. B&B Dental also relies on the cooperation of university and higher education institutions and entities, to further check the reliability of its offering by means of the latest cutting-edge technologies and techniques.

PRODUCTION

Our staff includes engineers, qualified mechanics and qualified technicians.

To manufacture the parts, B&B Dental uses latest generation CNC bar lathes, high-precision machinery, featuring tool dynamic correction and allowing compliance with tolerance ranges of ± 0.001 mm (1 micron).



QUALITY AND CONTROL

100% of our implants and screws passes strict quality and compliance checks, carried out both by a dedicated and trained team, and sophisticated Zeiss control machines. They promptly intervene in case of deviations compared to set parameters.

The packaging used for our sterile products is realized in-house within our white room, to guarantee cleanliness and hygiene.

Production quality is compliant with the EN ISO 13485 standard.



WAREHOUSE

The storage of most of the semi-finished and finished products is entrusted to automatic vertical warehouses which, in addition to rationalize space, allow operators to accurately prepare orders, through a completely computerised process.

TRAINING AND UPDATING

B&B Dental has always emphasised the importance of training for dentists by providing courses both at its own premises and around the world. It improves and enhances the experience with educational courses, webinars, workshops, live surgeries and courses on patient organised specifically to give users safety and knowledge of the products and their use.



CUSTOMER SERVICE

A widespread sales network with highly qualified staff attentive to the needs of customers provides suitable support to answer any questions and to give detailed information helping the customer in choosing the right product, understanding its application and use. Before and after sales assistance is ensured by qualified staff, skilled for technical and sales issues.

CERTIFICATIONS

B&B Dental has always been interested in obtaining new certificates that could prove its top-class production standards. B&B Dental currently has more than 30 international certificates and every year undergoes scheduled audits to maintain them.



IMPLANT SURFACE



B&B Dental ensures the highest quality of its products, allowing you to work safely and to obtain the best clinical and aesthetic results. The production is entirely made in Italy: this facilitates the accurate management of the production steps, realized both by B&B Dental specialized staff and by its high-tech machinery at its manufacturing location.

ETCHING SURFACE TREATMENT AND STERILISATION

After the production, the implant undergoes two delicate phases, entrusted to sector experts.

The chemical etching process creates a micro-roughness on the surface, at a microscopical level, allowing an optimal osseointegration.

The last step before packaging is the sterilization with gamma rays

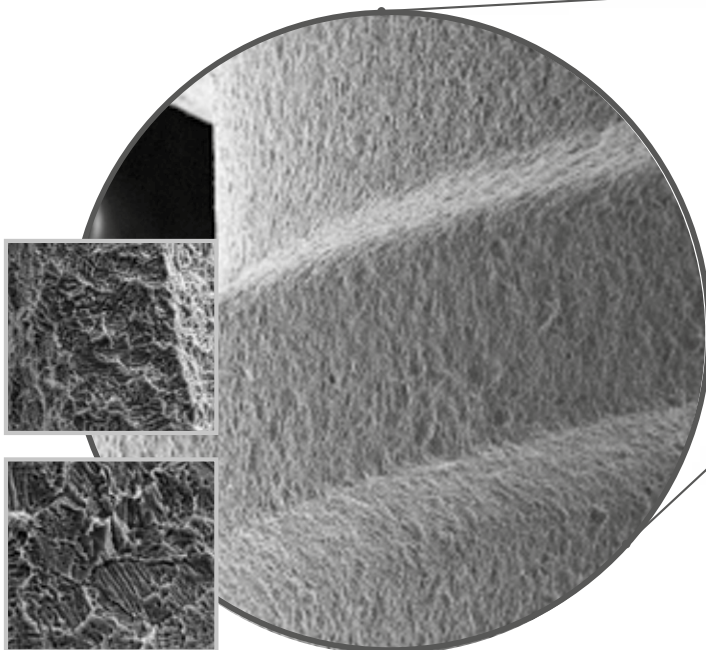

B&B DENTAL IMPLANT LINES

Discover all the implant lines of the Dura-vit range and their great potential: a complete system consisting of 6 lines designed to meet any need and two connections that simplify the handling of components in order to work in conditions of absolute safety.

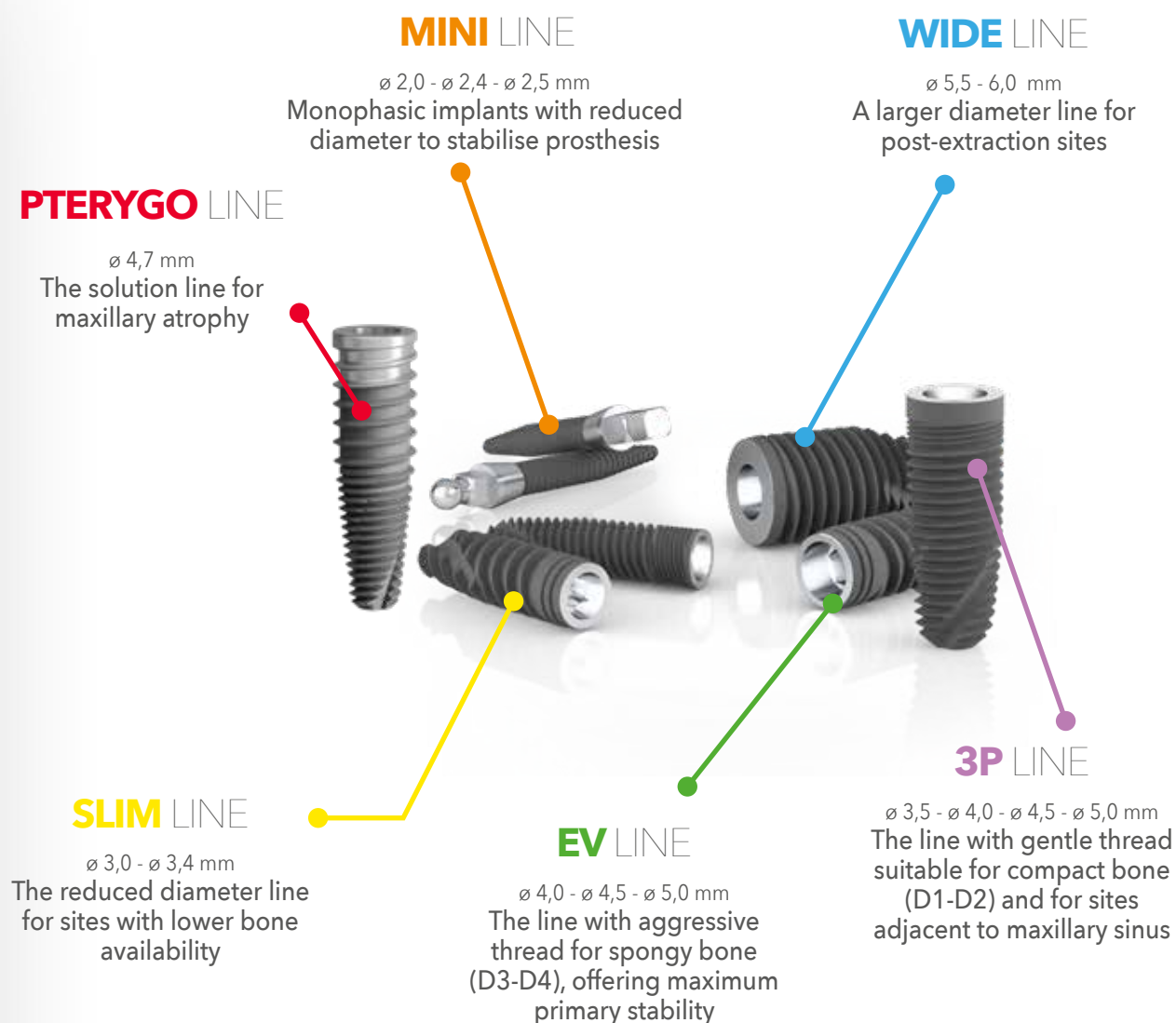

PACKAGING

The new packaging is safer and more practical thanks to its anti-tampering opening. Implant holder vial keeps the implant in position, ready to be picked up using ratchet or contra-angle drivers. In each implant packaging a healing screw and a cover cap are included.



SEALED PACKAGING

When packaging is sealed, the symbol is a closed lock of a neutral colour.



OPEN PACKAGING

After opening, the tab becomes red, with an open lock.





IMPLANT CERTIFICATE

A guarantee of the quality of the implant and parts used; it also specifies traceability details and useful information for their careful management.

INSTRUCTIONS FOR USE

Necessary to explain proper use and required precautions to be adopted with the medical device.











STERILE PACKAGING

Inside each packaging you will have an implant together with a healing screw and a cover screw.

ADDITIONAL LABELS

Useful to be applied on patient's file and documents to ensure the traceability of every implant.

DESCRIPTION OF SYMBOLS

	Expiry date		Product code		Batch number
	Gamma-ray sterilisation		Read the instruction sheet		The device must only be used by medical personnel
	Disposable		Date of production		Manufacturer

TIGHTENING INSTRUCTIONS

3P, EV, WIDE, PTERYGO LINES - CONEXA DURA-VIT CONNECTION

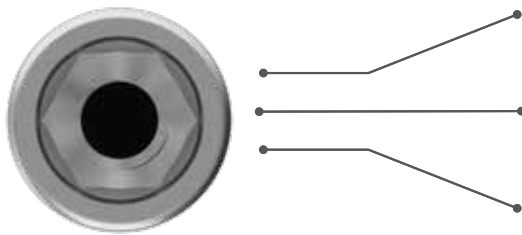

TRANSFERS
Finger force

PASSING SCREW ABUTMENTS

titanium, peek, Ti-links, Ti-bases, abutments from premilled
25 Ncm

PILLARS

MUA, spherical, flat, equator
25 Ncm

ABUTMENTS FOR MUA
titanium, castable, Ti-link

15 Ncm

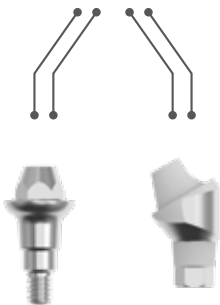

ABUTMENTS FOR FLAT
titanium, castable, Ti-link

20 Ncm



SLIM LINE - SLIM DURA-VIT CONNECTION

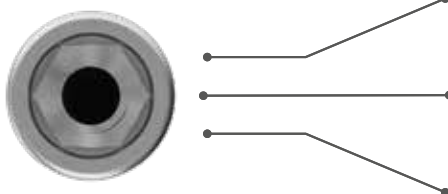

TRANSFERS
Finger force

PASSING SCREW ABUTMENTS

titanium, peek, Ti-links, Ti-bases, abutments from premilled
20 Ncm

PILLARS

spherical, flat, equator
20 Ncm

ABUTMENTS FOR FLAT

titanium, castable, Ti-link
15 Ncm



KEYS & DRIVERS TIGHTENING

PROSTHETIC SCREWDRIVERS



MAXIMUM 25 Ncm

CONTRA-ANGLE DRIVERS FOR IMPLANTS -

3P, EV, WIDE, PTERYGO LINES CONEXA DURA-VIT CONNECTION



MAXIMUM 35 Ncm

RATCHET DRIVERS FOR IMPLANTS -

3P, EV, WIDE, PTERYGO LINES CONEXA DURA-VIT CONNECTION



MAXIMUM 70 Ncm

CONTRA-ANGLE DRIVERS FOR IMPLANTS -

SLIM LINE SLIM DURA-VIT CONNECTION



MAXIMUM 35 Ncm

RATCHET DRIVERS FOR IMPLANTS -

SLIM LINE SLIM DURA-VIT CONNECTION



MAXIMUM 45 Ncm

RATCHET AND MANUAL DRIVERS FOR IMPLANTS -

MINI LINE MINI LINE CONNECTION



MAXIMUM 50 Ncm



CONEXA IMPLANTS



Implant of lines 3P, EV, Wide and Pterygo are equipped with a single connection called CONEXA. This taper connection prevents rotation and ensures high resistance to torsional loads thanks to the internal hexagon. In addition, the elimination of possible micro-movements through cold welding ensures the stability of hard and soft tissues, prosthetic components and their surrounding tissues while respecting the biological width. CONEXA connection is common to all lines and diameters, making it easier to choose transfers and abutments. Furthermore, surgical instruments are differentiated and colour-coded, making the choice intuitive and quick, while offering the highest degree of ergonomics and simplicity.





02.

CONEXA IMPLANTS



CONEXA CONNECTION

PROSTHETIC SCREW

- For abutment conometric locking.
- It is not subjected to loads, eliminating the risk of breakage or loosening.

PLATFORM SWITCHING

- Reduces possible bone loss.
- Provides excellent support for mucous tissues.
- Improves the aesthetic profile while preserving the biological width.
- Allows for greater load distribution.

TAPER CONNECTION "MORSE-TYPE" TAPER AT 5° TOTAL

- Cold welding
- Eliminates micro-movements
- Ensures an excellent bacterial sealing.

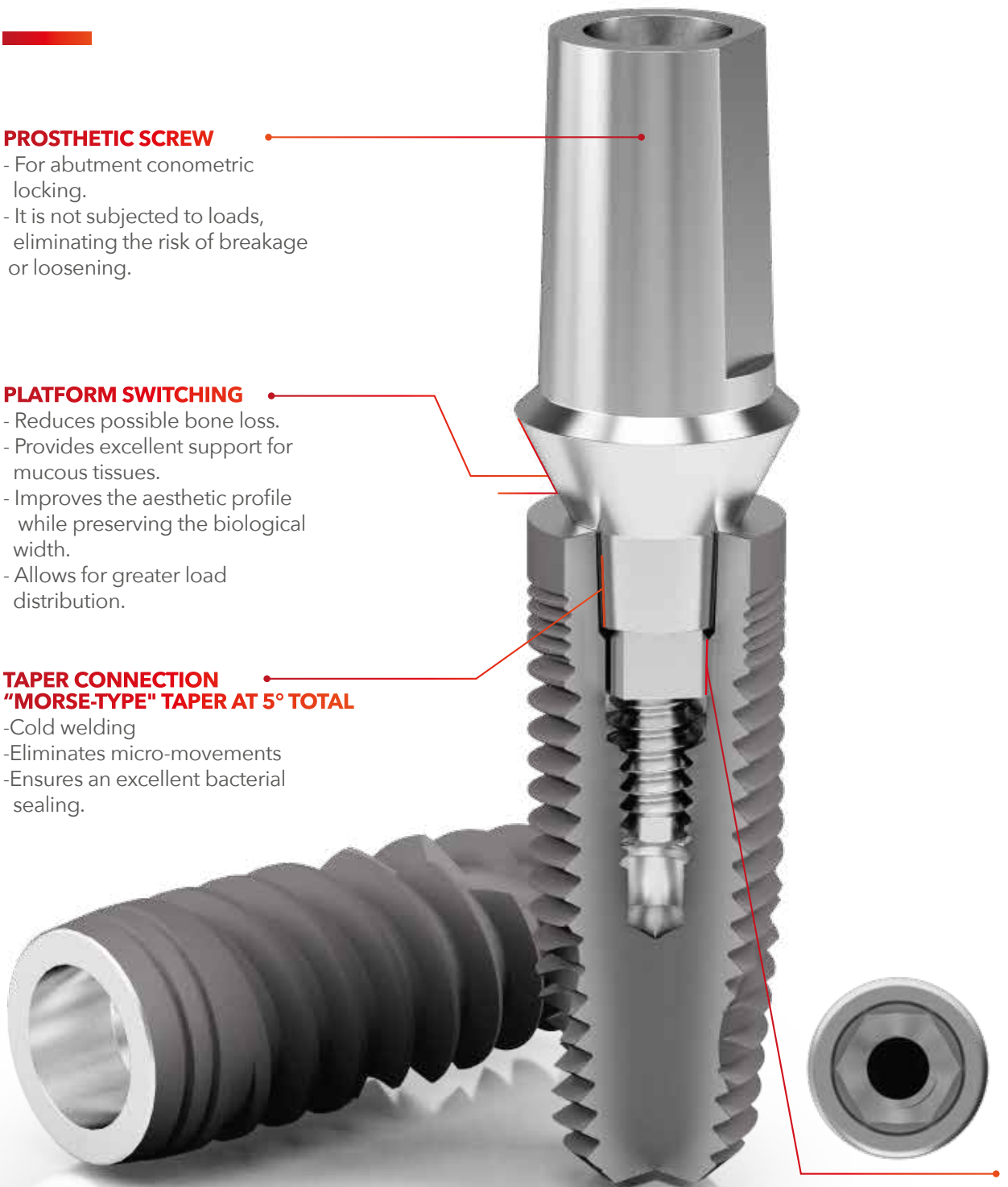

INTERNAL HEXAGON

It ensures anti-rotation feature for absolute abutment positioning precision.

SINGLE CONEXA CONNECTION

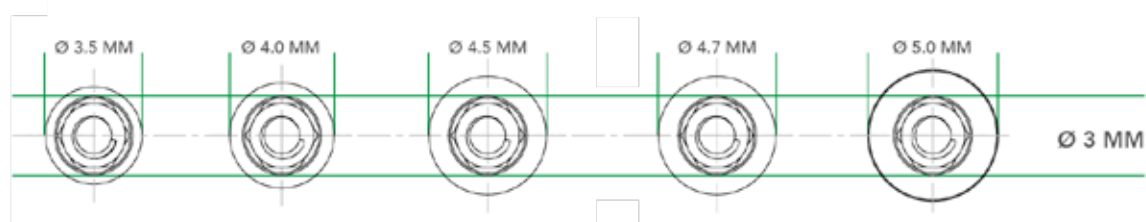

The components from the line DURA-VIT CONEXA are compatible with all diameters of the implant lines 3P, EV, WIDE and PTERYGO. Thanks to the special and single connection having an inside diameter of 3 mm, any chosen abutment can be placed in the implant, regardless of implant diameter.

UNLOCKING SYSTEM

When two taper surfaces are connected, a cold welding effect called "Morse" is created and the two parts (implant and abutment) engage together. This effect can be reversed by inserting an extractor screw or key.



LOW EXTRACTOR KEY
INN-6161S



SHORT EXTRACTOR KEY
INN-6161



LONG EXTRACTOR KEY
INN-6161L



EXTRACTOR SCREW
INN-6060

DURA-VIT CONEXA IMPLANTS

MORSE TAPER & INTERNAL HEXAGON

- Accurate positioning of prosthetic components
- Increased mating surface between implant and abutment
- High stability

COLLAR WITH REVERSE TAPER AND ANNULAR MICRO SPLINING

- Excellent support of soft tissues
- Maximum volume of alveolar bone
- Minor crestal bone resorption

SELF-TAPPING DOUBLE-THREAD SPIRAL

- Sharp double thread for spiral tap increased depth
- Ensure easy insertion and osteocondensation
- Very high primary stability

PENETRATING TIP

- Allows the implant to penetrate the pre-prepared site
- Ideal anchoring

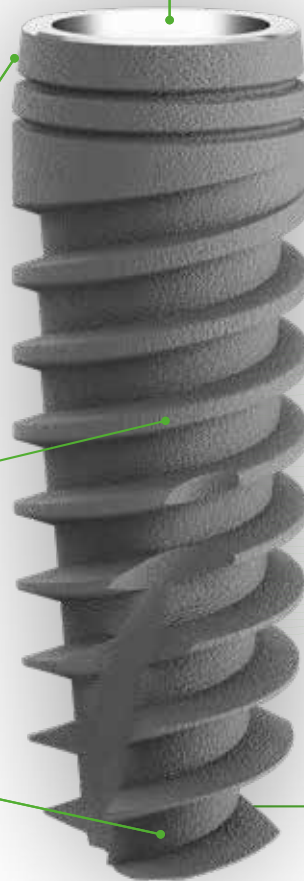















EV
LINE

PROPERTIES

- Ideal in spongy bone (D3-D4).
- Allows condensation.
- Ideal in post-extraction sites.
- Grade 4 Titanium.

EV • LINE

	L. 6.5	L. 8	L. 10	L. 12	L. 14	L. 16
ø 4		 EV-4008	 EV-4010	 EV-4012	 EV-4014	 EV-4016
ø 4,5	 EV-4506	 EV-4508	 EV-4510	 EV-4512	 EV-4514	
ø 5	 EV-5006	 EV-5008	 EV-5010	 EV-5012	 EV-5014	

COLOUR CODING OF INTERNAL TUBE IMPLANTS AND TOOLS

EV LINE colour code		ø 4,0		ø 4,5		ø 5,0
Final drill diameter D3 - D4 bone		ø 3,5		ø 4,0		ø 4,5
Final drill diameter D1 - D2 bone		ø 4,0		ø 4,5		ø 5,0

DURA-VIT CONEXA IMPLANTS

MORSE TAPER & INTERNAL HEXAGON

- Accurate positioning of prosthetic components
- Increased mating surface between implant and abutment
- High stability

COLLAR MICRO-THREADING

- Increases primary stability
- Makes implant placement easier
- Reduces vertical prosthesis load
- Helps soft tissue healing

TRIPLE-THREAD SPIRAL

- 60° bevelled profile threading
- Increases mating surface with bone to ensure less invasive procedures
- Improves osseointegration

"BONE-FRIENDLY" TIP

- The rounded shape helps lifting the maxillary sinus membrane
- Reduces the risk of perforation

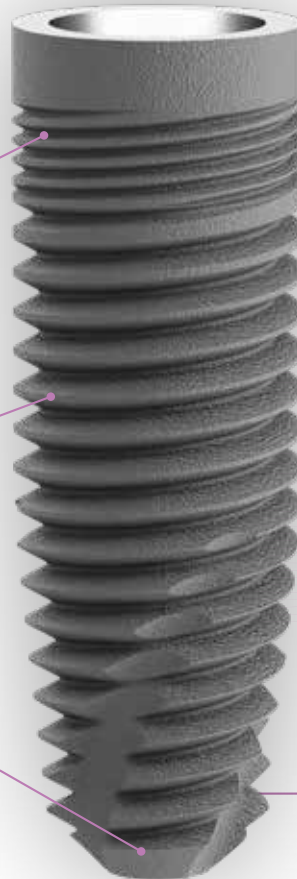



















3P
•
LINE

PROPERTIES

- Excellent in all bone types (especially D1-D2).
- Ensure high primary stability.
- Ideal in sites next to sinus or nerve.
- Grade 4 Titanium.

3P • LINE

	L. 6.5	L. 8	L. 10	L. 12	L. 14
ø 3,5		 3P-3508	 3P-3510	 3P-3512	 3P-3514
ø 4	 3P-4006	 3P-4008	 3P-4010	 3P-4012	 3P-4014
ø 4,5		 3P-4508	 3P-4510	 3P-4512	 3P-4514
ø 5	 3P-5006	 3P-5008	 3P-5010	 3P-5012	 3P-5014

COLOUR CODING OF INTERNAL TUBE IMPLANTS AND TOOLS

3P LINE colour code	 ø 3,5	 ø 4,0	 ø 4,5	 ø 5,0
Final drill diameter D1 - D2 bone	ø 3,5	ø 4,0	ø 4,5	ø 5,0
Final countersink diameter D1-D2 bone	ø 3,5/4	ø 3,5/4	ø 4,5/5	ø 4,5/5
Final compactor diameter D3 - D4 bone	ø 3,5	ø 4,0	ø 4,5	ø 5,0



DURA-VIT CONEXA IMPLANTS



MORSE TAPER & INTERNAL HEXAGON

- Accurate positioning of prosthetic components
- Increased mating surface between implant and abutment
- High stability

COLLAR WITH REVERSE TAPER AND ANNULAR MICRO SPLINING

- Excellent support of soft tissues
- Maximum volume of alveolar bone
- Minor crestal bone resorption

TRIPLE-THREAD SPIRAL

- 60° bevelled profile threading
- Increases mating surface with bone to ensure less invasive procedures
- Improves osseointegration

"BONE-FRIENDLY" TIP

- The rounded shape helps lifting the maxillary sinus membrane
- Reduces the risk of perforation

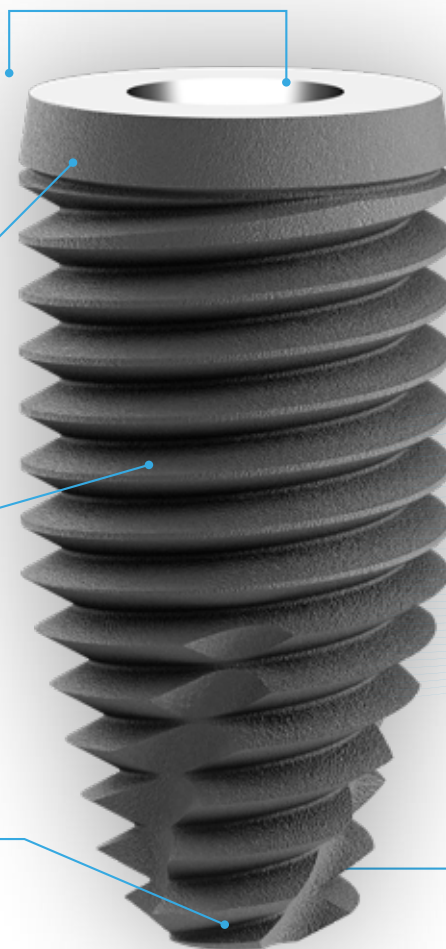











WIDE
•
LINE

PROPERTIES

- Allows placing an implant in a premolar and molar extraction site
- Maximises bone preservation
- Minimises instances of required bone grafting
- Grade 4 Titanium.



WIDE • LINE

	L. 6.5	L. 8	L. 10	L. 12	L. 14
ø 5.5	 WIDE-5506	 WIDE-5508	 WIDE-5510	 WIDE-5512	 WIDE-5514
ø 6	 WIDE-6006	 WIDE-6008	 WIDE-6010	 WIDE-6012	 WIDE-6014

COLOUR CODING OF INTERNAL TUBE IMPLANTS AND TOOLS

WIDE LINE colour code	 ø 5,5	 ø 6,0
Final drill diameter	ø 5,5	ø 6,0

DURA-VIT CONEXA IMPLANTS



MORSE TAPER & INTERNAL HEXAGON

- Precise positioning of prosthetic components
- Increased contact area between implant surface and abutment
- High stability

COLLAR WITH MACHINED SURFACE

- Maximum cleanability

MODULAR THREADS AND GRADUAL TAPERING

- Threads suitable for different bone densities
- Ideal for easy insertion along the entire length of the implant

"BONE FRIENDLY" APEX

- The rounded shape helps lifting the maxillary sinus membrane
- Reduces the risk of perforation

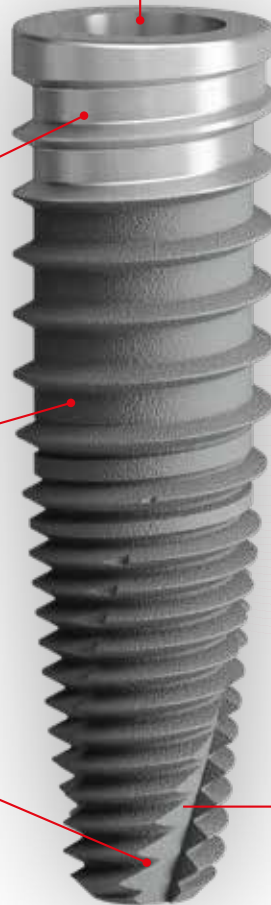

PTERYGO • LINE

PROPERTIES

- Specific implant design for insertion in the pterygoid region
- Maximises bone preservation and
- Minimises instances of required bone grafting or sinus lifting
- Grade 4 Titanium.



PTERYGO • LINE

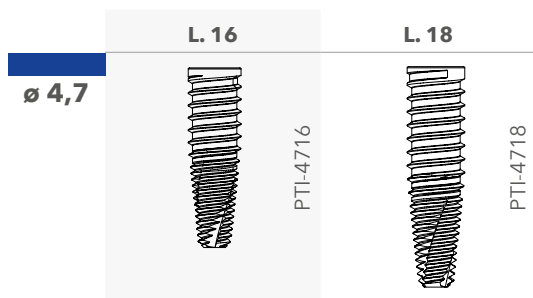

COLOUR CODING OF INTERNAL TUBE IMPLANTS AND TOOLS

PTERYGO LINE colour code	 ø 4,7
Final drill diameter	ø 4,7



HEALING COMPONENTS

COVER SCREW (grade 5 Titanium)

It is used to completely cover the implant after placing it. Implant site reopening, after 3 to 6 months, requires the use of the healing screw. **One standard size screw (INN-6053)** is available inside each implant packaging.



TIGHTENING:

Recommended tightening: max 10 Ncm.

HEALING SCREW (grade 5 Titanium)

It is used for mucosal healing and conditioning in case of gum reopening, duly adapted by means of suture. These components are used to rehabilitate soft tissues above the implant so that the final prosthetic abutment can be placed. It can be used for surgery in one or two sessions.

The components are laser-marked for easy recognition of diameter and length.

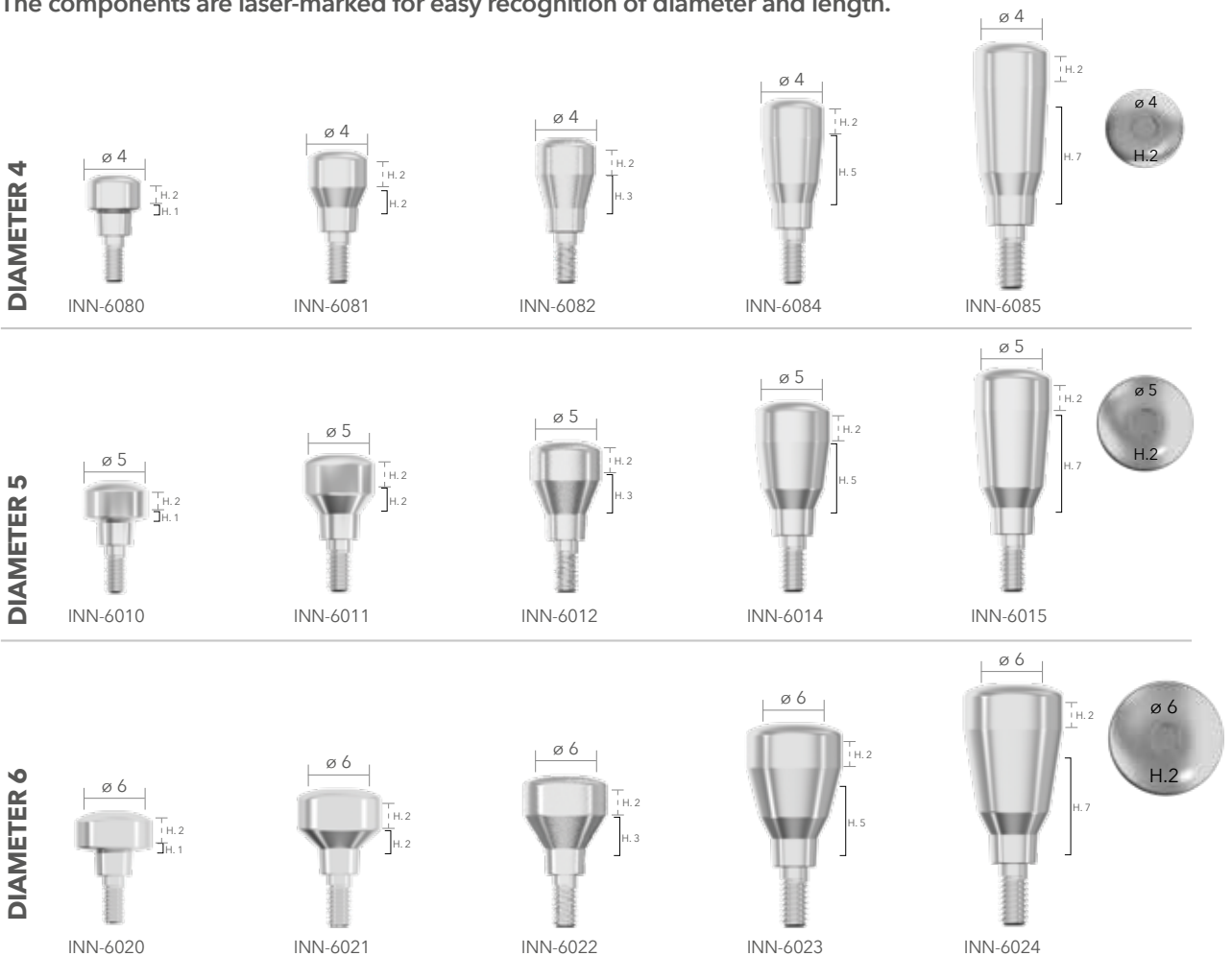

TIGHTENING: Recommended tightening: max 20 Ncm.

COMPONENTS FOR IMPRESSIONS

PULL-OFF TRANSFERS

To be used with standard tray holder, with closed-tray technique, they are press-fitted.

For this type of transfer, it is important to use tear-resistant materials.



TRANSFER
3 pcs pack
INN-00306

FACILITY TRANSFERS

Use with a standard tray holder with closed-tray technique: by tightening the transfer coping in the implant and positioning the plastic cap in place it will be possible to obtain a clear positioning in the impression.



PLASTIC CAP
2 pcs pack
INN-00507

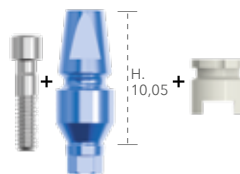

SHORT SET
Short metal transfer with
plastic cap
INN-00506

This code includes a
transfer screw INN-6050

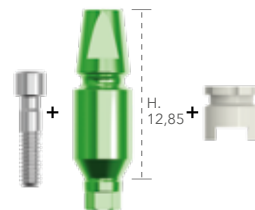

LONG SET
Long metal transfer with
plastic cap
INN-00506L

This code includes a
transfer screw INN-6050

PICK-UP TRANSFERS

To be used with open tray holder, with open spoon technique, by screwing the transfer inside the implant it will be possible to obtain a clear positioning in the impression.

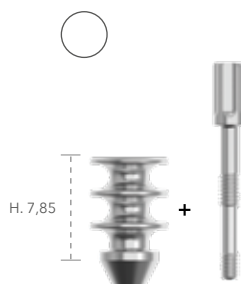

**ROTATING METAL
TRANSFER**
metal transfer
INN-00601

This code includes a transfer
screw INN-00608

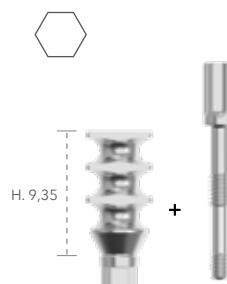

**HEX CONNECTION
SHORT METAL TRANSFER**
metal transfer
INN-00600

This code includes a transfer
screw INN-00608

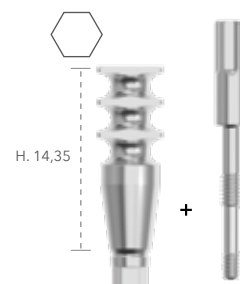

**HEX CONNECTION LONG
METAL TRANSFER**
metal transfer
INN-00600L

This code includes a transfer
screw INN-00608L

ANALOGUES

Analogues reproduce the implant shape and connection inside the model. They must be carefully placed on the transfers inside the impression before proceeding with the model pouring.



ANALOG
INN-00585



**STANDARD 3D
ANALOG**
3D-00585

This code includes screw
3D-02

TEMPORARY PROSTHETIC COMPONENTS

TRY-INN ABUTMENTS KIT

Try-Inn abutments Kit helps dental technicians in selecting the most appropriate titanium abutment, depending on inclination and transmucosal height of the implant that was inserted.

CHARACTERISTICS

- Ease of use.
- Abutments are colour-coded and marked, easy to read and their choice can be planned.
- Easy to handle thanks to the plastic tab.
- Proper positioning of the TRY-Inn abutments is checked thanks to the accurate feedback by the prosthesis connection.
- Try-Inn Abutments are made of a polymeric material that can be sterilised.

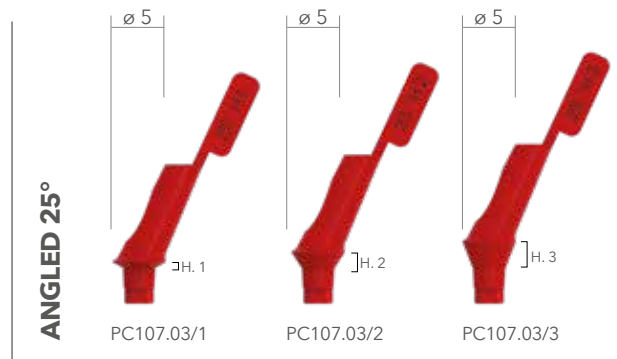
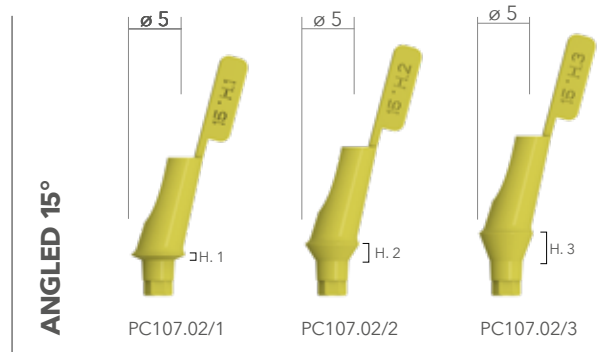
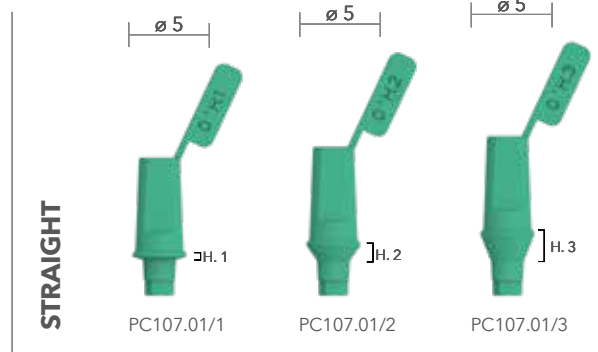

TRY-INN KIT

000.07

The kit includes 3 pieces of every code

The codes for the corresponding ø 5 abutments are specified at the back of the package to help the ordering procedure.

TEMPORARY ABUTMENTS IN PEEK

These temporary abutments were designed to be easily customised both on the spot by the practitioner and at the laboratory, by the technician and can be used for:

- Immediate installation.
- Management of soft tissues in aesthetic areas.
- Temporary retention of cemented or screw-retained crowns.

These abutments have a taper coupling.

CHARACTERISTICS

- Made from PEEK: extremely easy to adapt and modify
- Neutral colour for excellent aesthetic results
- Completely metal-free
- Conexa Connection.

IMPORTANT NOTE

Proper position of angled abutments can be checked by ensuring that the driver external hexagon is aligned with the internal hexagon.



TIGHTENING: Recommended tightening 25 Ncm. Check tightening torques and procedures on pages 11-12.

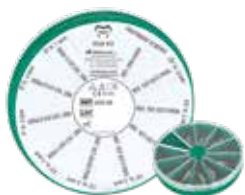

INN-6050

This code includes screw INN-6050

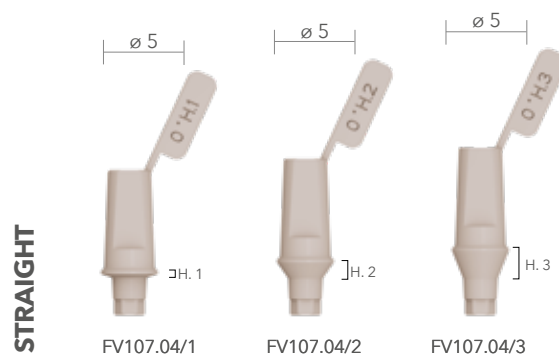

This code includes screw INN-6050

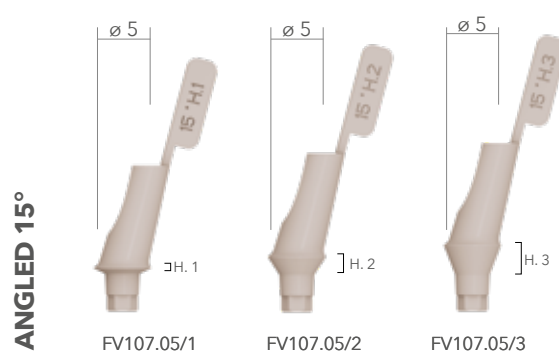

This code includes screw INN-6050

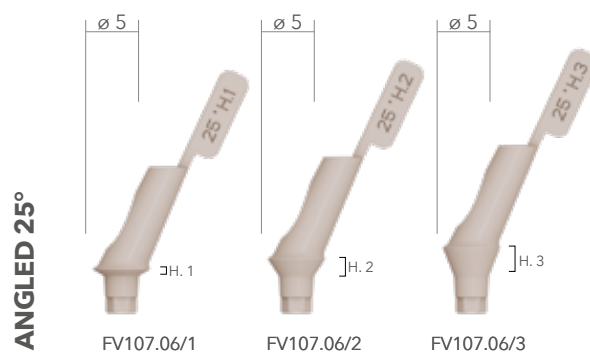

PEEK KIT

000.08

The kit includes 3 pieces of every code

The codes for the corresponding $\varnothing 5$ abutments are specified at the back of the package to help the ordering procedure.

ABUTMENTS POSITIONER

The positioner is used to bring the abutment into place easily. It is necessary to disassemble the positioner before proceeding with the insertion of the prosthetic screw.

TEMPORARY ABUTMENTS IN TITANIUM

Abutments for cemented temporary prosthesis, easy to customise.

Non-ROTATING abutments can be used for:

- Single temporary crowns;
- Cemented temporary bridges.

ROTATING abutments are used in screw-retained temporary bridges.

- Small diameter for interdental spaces
- Made from titanium for an accurate coupling and high stability

These abutments have a taper coupling.

CHARACTERISTICS

-They can be easily customised both on the spot by the practitioner and at the laboratory by the technician.

- Conexa Connection

IMPORTANT NOTE

Do not use for a period over 180 days.
Place the temporary abutments at subocclusal level.
Do not shorten by more than 6 mm using standard tools and techniques.

ABUTMENTS WITHOUT SHOULDER

Abutments for cemented temporary prosthesis, easy to customise.

These abutments have a taper coupling.

CHARACTERISTICS

-They can be easily customised by the practitioner and by the technician.

- Abutment for intraoral welding is in Titanium grade 4
- Conexa Connection

POSITIONER



**ABUTMENT
POSITIONER KEY**
INN-62000



**SHORT ABUTMENT
POSITIONER KEY**
INN-62000/S

STRAIGHT, NON-ROTATING

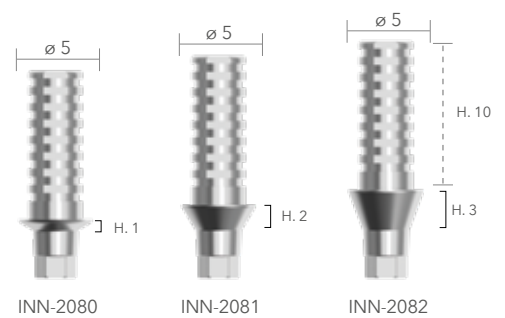

This code includes screw INN-6050

STRAIGHT, ROTATING

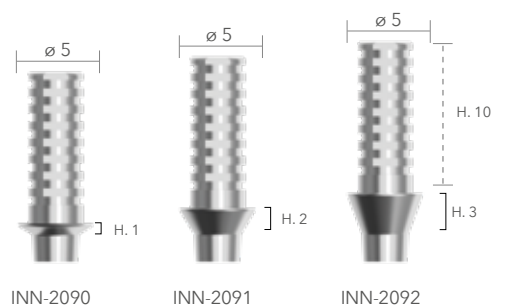

This code includes screw INN-6050

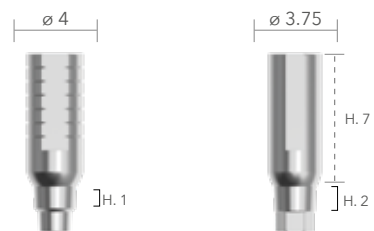

**ROTATING
ABUTMENT**
INN-00738
for intraoral welding

**NON-ROTATING
ABUTMENT**
INN-00742

DEFINITIVE PROSTHETIC COMPONENTS

UCLA ABUTMENTS

UCLA abutments can be used for:

- Over structures.
- Cemented prosthesis.
- Screw-retained prosthesis.

These abutments have a taper coupling.

CHARACTERISTICS

- Completely customisable.
- Conexa Connection.

STRAIGHT, NON-ROTATING

This code includes screw INN-6050

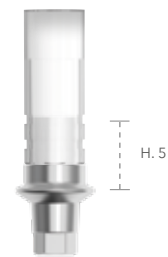

INN-6048CC
Cr-Co

STRAIGHT, ROTATING

This code includes screw INN-6050



INN-6048CC/R
Cr-Co



INN-6050

IMPORTANT NOTE

-Use the castable abutment only in case of extreme divergent conditions.



TIGHTENING: Recommended tightening : 25 Ncm. Check tightening torques and procedures on pages 11- 12.

STRAIGHT TITANIUM ABUTMENTS

They are titanium components mainly used for cemented prosthesis in the front areas.

These abutments have a taper coupling.

CHARACTERISTICS

- Reduced need for touching-ups thanks to prepared mucosal margins.
- Different transmucosal heights to adapt to various profiles.
- Cylindrical shape similar to the emerging profile of a natural tooth.
- Conexa Connection.

IMPORTANT NOTE

- NOT suitable for direct coating with ceramic.
- DO NOT shorten more than 3 mm above the mucosal margin.
- DO NOT position cement limit more than 2 mm below mucosal level.
- It is recommended to use a new screw to place the abutment.

4 mm DIAMETER

This code includes screw INN-6050

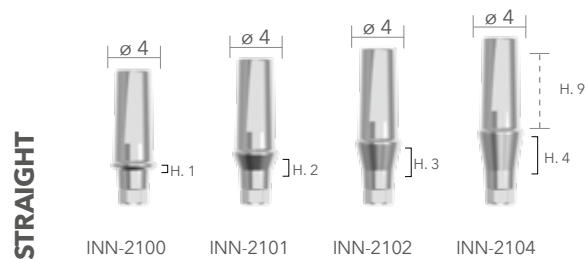

5 mm DIAMETER

This code includes screw INN-6050

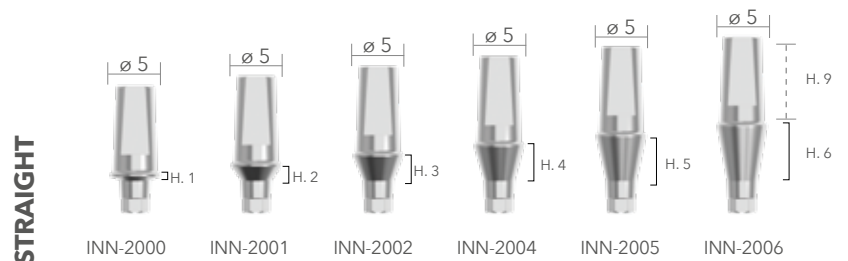

6 mm DIAMETER

This code includes screw INN-6050

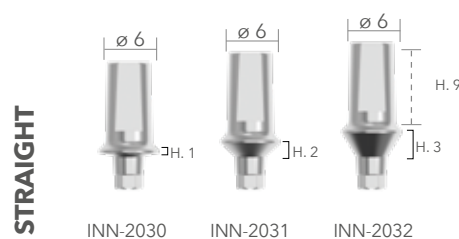

TIGHTENING: Recommended tightening: 25 Ncm. Check tightening torques and procedures on pages 11-12.

ANGLED TITANIUM ABUTMENTS

They are titanium components mainly used for cemented prosthesis in the front areas.

These abutments have a taper coupling.

CHARACTERISTICS

- Reduced need for touch-ups thanks to prepared mucosal margins.
- Different transmucosal heights to adapt to various profiles.
- Cylindrical shape similar to the emerging profile of a natural tooth.
- Conexa Connection.

IMPORTANT NOTE

- NOT suitable for direct coating with ceramic.
- DO NOT shorten more than 3 mm above the mucosal margin.
- DO NOT position cement limit more than 2 mm below mucosal level.
- It is recommended to use a new screw to place the abutment.

4 mm DIAMETER

This code includes screw INN-6050

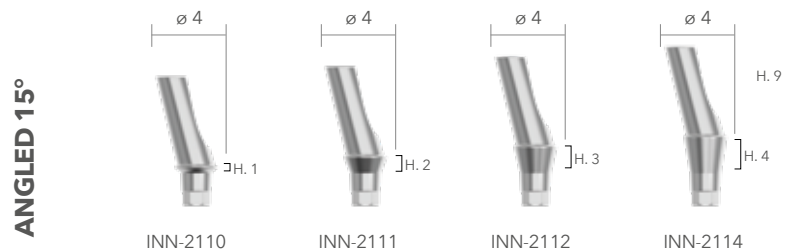

5 mm DIAMETER

This code includes screw INN-6050

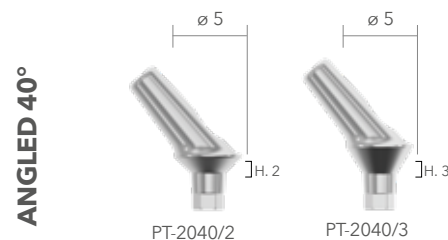
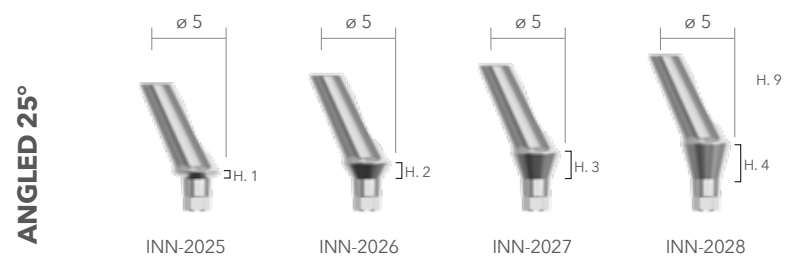
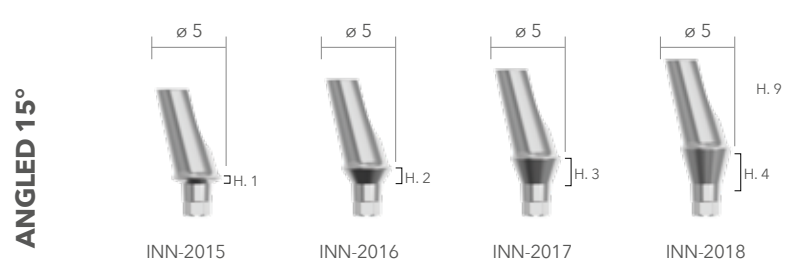

6 mm DIAMETER

This code includes screw INN-6050

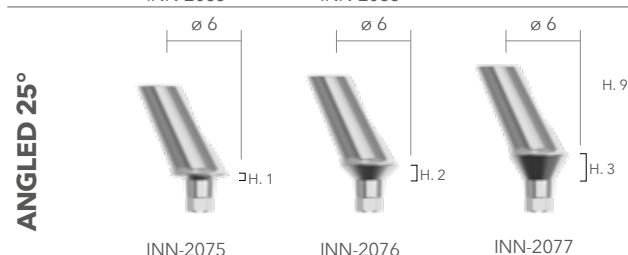
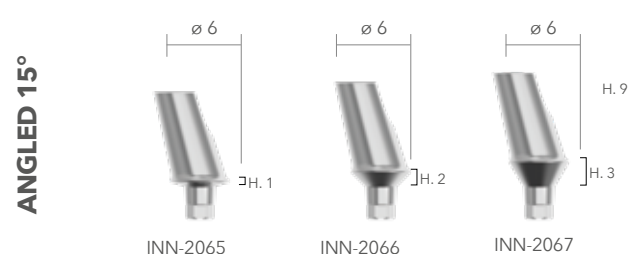

SCAN COMPONENTS

These are components for impression-taking with digital intraoral scanners.

The scan caps must be placed onto the TI-links, properly placed in the patient's mouth, while scanbodies must be directly connected to the implant.

IMPORTANT NOTE

It is necessary to prepare B&B Dental libraries within your own design software to use these components. Send us an e-mail to receive the libraries.

TI LINK 3P/EV/WIDE

They are titanium components mainly used for cemented prosthesis with digital technologies.

These abutments have a taper coupling.

CHARACTERISTICS

- Reduced need for touching-ups thanks to prepared mucosal margins.
- Different transmucosal heights to adapt to various profiles.
- Cylindrical shape similar to the emerging profile of a natural tooth.
- Conexa Connection.

This code includes screw INN-6050

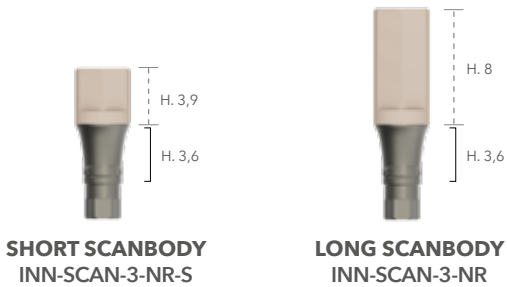

NON-ROTATING BASE

This code includes screw INN-6050

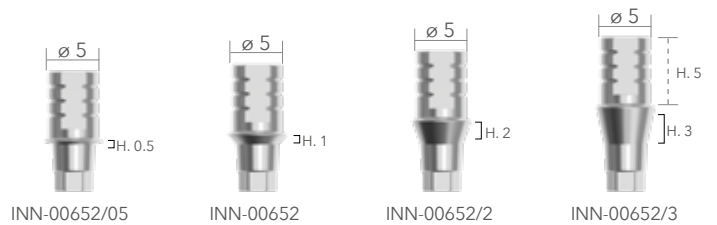

ROTATING BASE

This code includes screw INN-6050

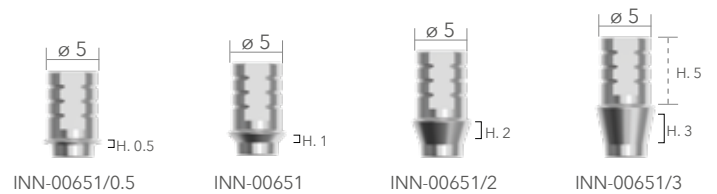

CASTABLE CYLINDER



INN-0430

INN-6050



PREMILLED BASES

Premilled bases are used for the construction of customised milled abutments. These components are characterised by conexa connection certified by B&B Dental.

3D ANALOGUES

3D analogues can be fixed in the printed models in which they are placed.

TI BASE CEREC® (L LINE)

They are titanium components used for cemented prosthesis and tightened using digital technologies.

These abutments have a taper coupling.

CHARACTERISTICS

- Titanium base.
- Completely customisable prosthesis.
- Use of CAD/CAM technology to produce zirconium abutments to be glued onto the central abutment.
- Conexa Connection.



TIGHTENING :
Recommended tightening: 25 Ncm. Check tightening torques and procedures on pages 11-12.

PREMILLED MEDENTIKA

This code includes screw INN-6050

also available upon request for NT-trading and Des holreds



INN-CF5123 Ti
INN-CB512 Cr-Co



INN-CF5125 Ti
INN-CB5125 Cr-Co



STANDARD 3D ANALOG
3D-00585
This code includes screw 3D-02

This code includes screw INN-6050



INN-00655



INN-00655/2

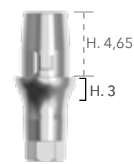

INN-00655/3



NOTE:

Scanbody items are placed on ScanPost and TiBase for implant data optical acquisition. The grey cap is used with the omnicam system. The white cap is used with the bluecam system. Two connections are available:
- S - compatible for SLIM (code: 6431295 -6431311)
- L - compatible for conexa line (code: 6431303 - 6431329)



MULTI-USE ABUTMENTS

STRAIGHT MULTI-USE ABUTMENTS

Straight multi-use abutments must be fixed directly to the implant using a multi-use driver (a manual one or with a ratchet).

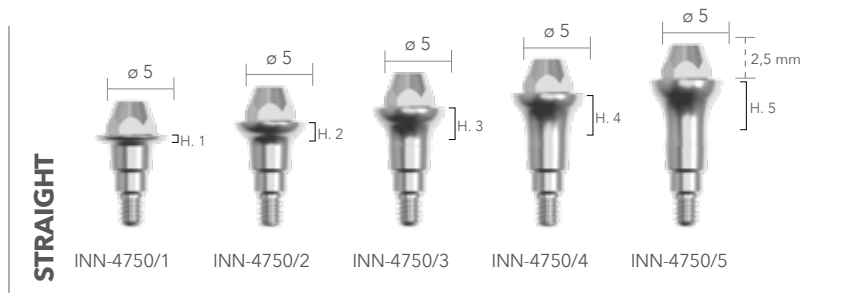

ANGLED MULTI-USE ABUTMENTS

Angled multi-use abutments at 17 and 30 degrees help achieving parallelism in case of implants having a different inclination. Easy connection to the implant using a preassembled transfer (Ref. 023MUA). Then, they are fastened by a prosthetic screw.



TIGHTENING :
Recommended tightening : 25 Ncm. Check tightening torques and procedures on pages 11- 12

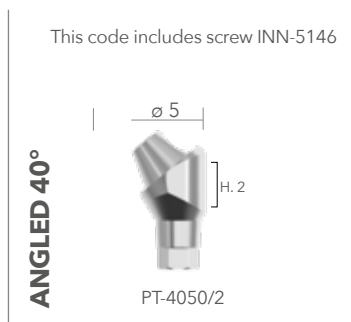
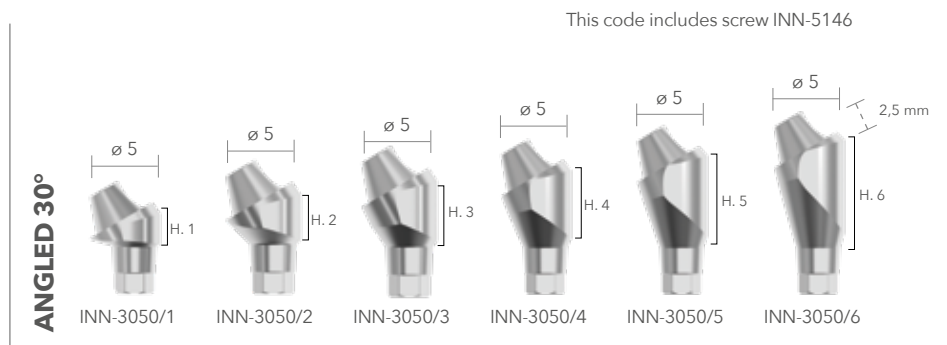
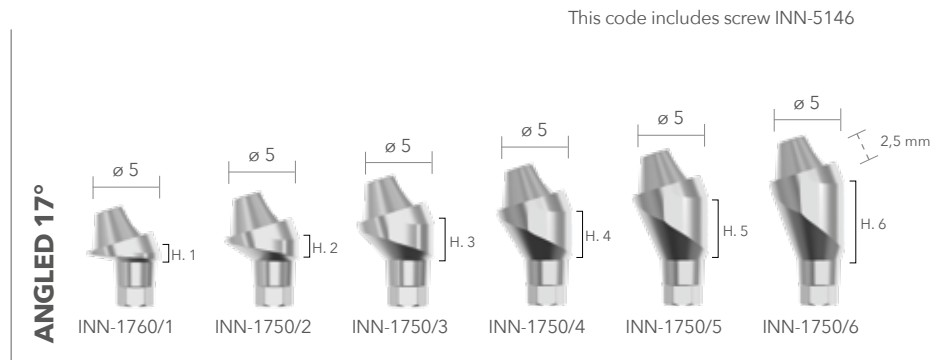

MUA TOOLS



**O-BALL AND STRAIGHT MUA
TORQUE RATCHET DRIVER**
INN-00637



BONE REAMER
GD-BM

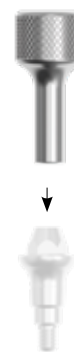

**O-BALL AND STRAIGHT MUA
MANUAL DRIVER**
00440M

The positioner is used to easily bring the MUA abutment into position in order to insert the primary screw.



**ANGLED MEASUREMENT
TOOL FOR MUA**
024-MUA



MUA HOLDER
023-MUA

Multi-use abutments rely on a tapered connection at the top, on which MUA line abutments must be screwed to obtain:

- Screw-retained bridges.
- All-on-4 and all-on-6 prosthesis.
- Bars on implants with prosthesis.

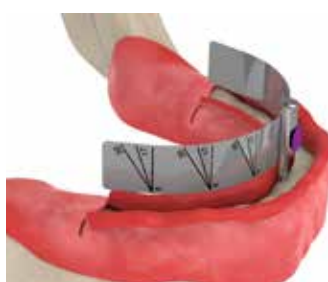

**ALL ON FOUR
GUIDE ARCH**
INN-3017

HEALING SCREWS

It is used in the patient's healing phase to protect the MUA abutment until prosthesis application.



HEALING CAP SCREW
INN-6030

TRANSFERS

The transfer is screwed onto the MUA for precise position adjustment during the impression taking step.



CLOSED TRAY TRANSFER
INN-00611

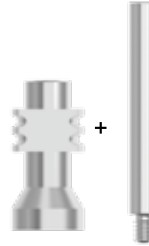

OPEN TRAY TRANSFER

INN-00610

This code includes screw INN-00612

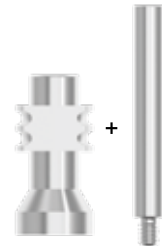

NON-ROTATING OPEN TRAY TRANSFER

INN-005001

This code includes screw INN-00612

ABUTMENTS FOR MUA

These abutments must be fixed onto the MUAs to build structures.

They are available in two versions:

- rotating
- non-rotating



This code includes screw INN-6051

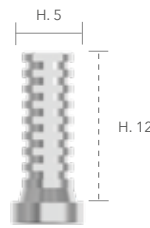

TEMPORARY ABUTMENT
INN-5144

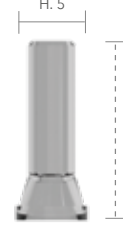

CASTABLE ABUTMENT
INN-5145

The non-rotating abutment can be used in single solutions



This code includes screw INN-6051

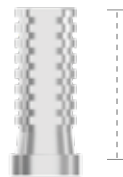

NON-ROTATING MUA TEMPORARY ABUTMENT
PVF301

UCLA FOR MUA

Castable abutment with cobalt chrome base. This abutment should be placed over both straight and angled MUAs



This code includes screw INN-6051
MUA CHROME COBALT UCLA ABUTMENT + SCREW
INN-6048

ANALOGUES

Analogues reproduce the implant shape and connection inside the model. They must be carefully placed on the transfers inside the impression before proceeding with model pouring.



MUA ANALOG
INN-00586



NON-ROTATING MUA ANALOG
INN-00586/NR



TIGHTENING: Recommended tightening: 15 Ncm. check tightening torques and procedures on pages 11- 12.



INN-6051

This code includes screw INN-6051

MUA DIGITAL TOOLS

The digital components are specifically designed to be used with scanner and printer. Please send us an e-mail to receive the libraries.

SCANS FOR MUA

The MUA scan is a NON-rotating tool to take impressions by means of intraoral scanners.

This code includes screw INN-6051



TI LINK BASES FOR MUA

MUA bases are supplied in two different heights in order to allow the creation of crowns featuring a straight screw hole.

This code includes screw 3D-14

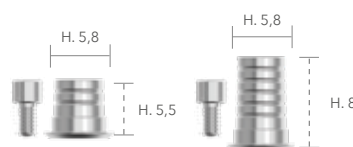

TI LINK FOR MUA
3D-5144 3D-5145

TI LINK BASES FOR MUA FOR INCLINED HOLE

It is provided to allow the creation of crowns featuring an angled screw hole.

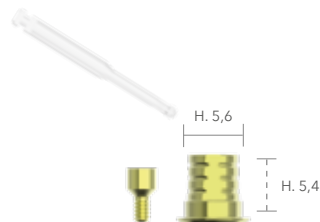

MUA BASE FOR INCLINED HOLE
3D-5143

KEYS FOR INCLINED HOLES

These keys are designed to tighten and loosen the screws in case of inclined hole (code 3D-14).



3D ANALOGUES

3D analogues allow screwing and unscrewing of the bases from the models in which they were placed.



MUA 3D ANALOG
3D-00586
This code includes screw 3D-02

IMPORTANT NOTE

To use these components it is necessary to have the B&B Dental libraries. You will find the software libraries in the "download" section of our site. Contact us for further support.

CONICAL SYSTEM

The conical system transfers the clinically proven stability of the taper abutment connection to the abutment-prosthesis connection. This second conical connection ensures the final positioning of the prosthesis by minimising spaces and micromovements.

Compared to bar restorations or other pre-fabricated connection components, this solution offers stable friction-locked connection that helps avoiding problems related to the difficulty of designing with the mesostructure.

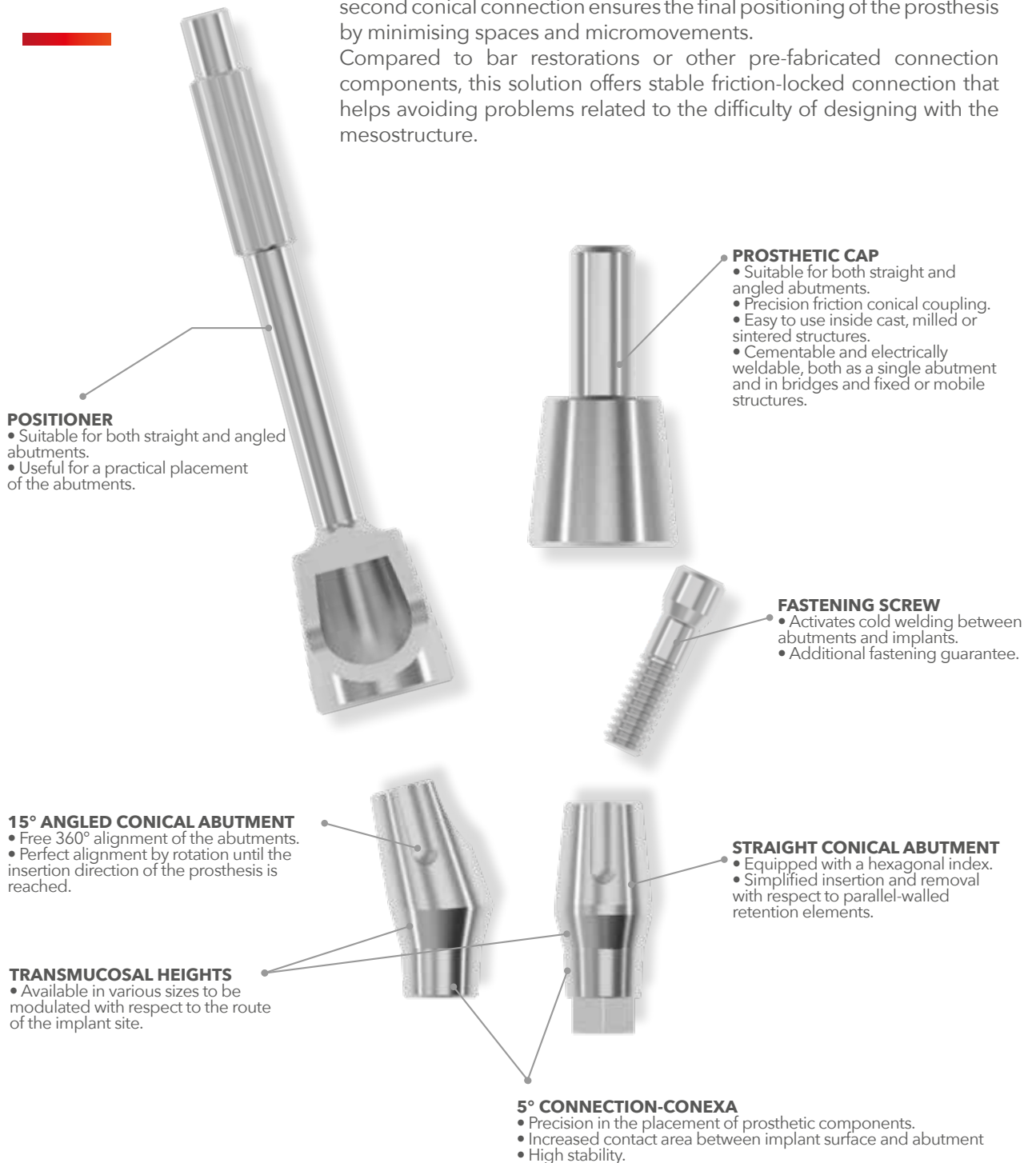

IMPORTANT NOTE

The recommended clamping torque is 15Ncm.

Use the screwdrivers or the extraction screw to disengage the abutments.

CONICAL ABUTMENTS

Conical abutments provide a stable connection for quick and economical rehabilitation with immediate-load prostheses. For delayed loads these abutments can be used as prefabricated retention elements. The angles of the abutments in the line allow better parallelisation while the intra oral gluing guarantees passive positioning of the prosthesis.

FEATURES

- Usable for fixed and removable prosthesis.
- Maximum possible reduction in the size of the prosthetic body to facilitate cleaning and comfort.
- Immediate restoration in 2 hours with existing prosthesis.
- Long-term stability for hard and soft tissues.
- The abutments go in tapered pair with the CONEXA line implants, for disengagement use the screws or the extractor screwdrivers.

STRAIGHT - NON-ROTATING



ANGLED 15° - ROTATING

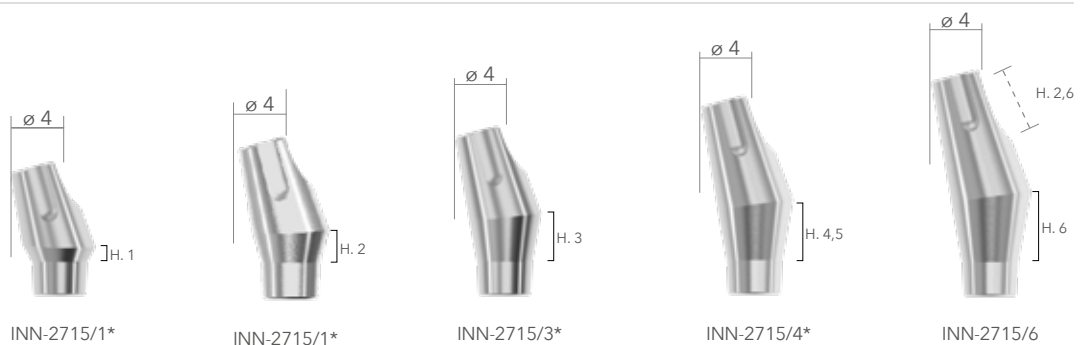

*This code includes screw INN-5146

COMPONENTS AND ACCESSORIES

The conical abutments are equipped with a dedicated component allowing simplified positioning in the mouth and practical taking of the impression. The prosthetic cap can be used for both fixed and removable prostheses and is equipped with a plug allowing electro-welding. The analogue reproduces the geometries of both straight and angled abutments. All components are compatible with B&B Dental prosthetic screwdrivers.



CONICAL ABUTMENT
CUP
INN-2700

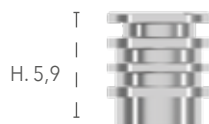

CONICAL CUP FOR
IMPRESSION
INN-2698



CONICAL
ANALOGUE
INN-2695



CONICAL CUP FOR
PARALLELISM
INN-2699

FLAT ANCHORING SYSTEM

FLAT ABUTMENTS

The flat abutments directly screw onto the implant and are ideal for the reconstruction of complete arches since their design ensures flexibility in a clinical situation where implants are not parallel, keeping the withdrawal axis not beyond 15° for convergent and divergent implants. These abutments simulate the external connection.

- Screw-retained prosthesis.
- Bar-type prosthesis on implants.
- Immediate installation.

CHARACTERISTICS

- Allow production of stable prosthesis
- Suitable for aesthetic areas.

IMPORTANT NOTE

Do not use whenever implant divergence exceeds 15°.

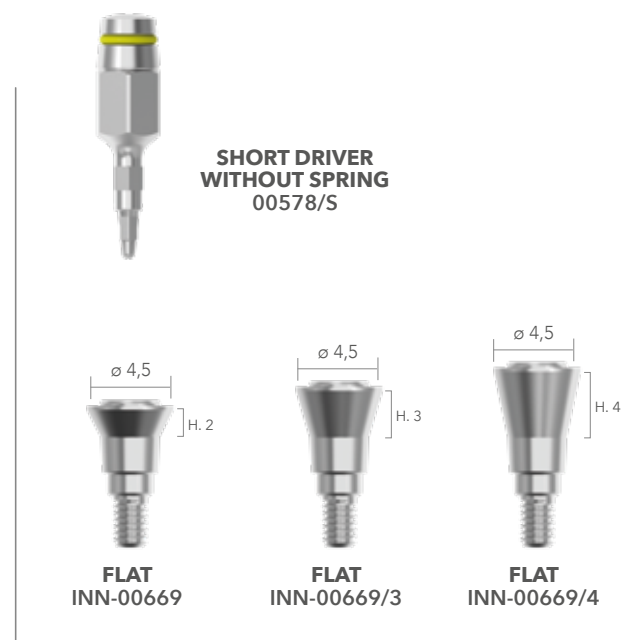

HEALING SCREW

It is used for mucosal healing and conditioning, on top of FLATs. These components are used to rehabilitate soft tissues above the implant so that the final prosthetic abutment can be placed.



TRANSFERS

The transfer must be placed onto the FLAT to accurately adjust the position. In this case, use the FLAT analogue.



ANALOGUES

Analogues reproduce the implant shape and connection inside the model. They must be carefully placed on the transfers inside the impression before proceeding with model pouring.



ABUTMENTS FOR FLAT

These abutments must be fitted onto the FLATs to create prosthetic crowns.

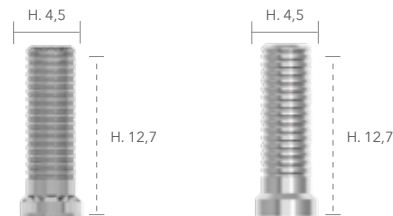

**CASTABLE
ABUTMENT
INN-00687**
This code includes
screw INN-00690

**TITANIUM
ABUTMENT
INN-00687/1**
This code includes
screw INN-00690

FLAT DIGITAL TOOLS

The digital components are specifically designed to be used with intraoral scanner. Please send us an e-mail to receive the libraries.

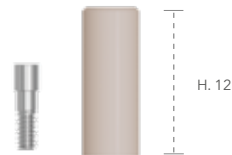

**SCAN FLAT
SCAN-FLAT**
This code includes screw INN-00690

SCAN FOR FLAT

The FLAT scan is a rotating tool to take impressions by means of intraoral or laboratory scanners.



**FLAT BASE
3D-00687/2**
This code includes screw INN-00690

TI LINK BASES FOR FLAT

FLAT bases are useful for anchoring prosthetic crowns on top of FLATs. This solution does not feature a geometric index.

TI LINK BASES FOR FLAT FOR INCLINED HOLE

It is provided to allow the creation of crowns featuring an angled screw hole.



The base code 3D-00687/1 can be used for inclined holes, by separately purchasing screw code 3D-16



**FLAT BASE FOR INCLINED HOLES
3D-00687/1**
This code includes screw INN-00690

3D ANALOGUES

3D analogues can be fixed in the printed models in which they are placed.



**FLAT 3D ANALOG
3D-00736**
This code includes screw 3D-02



TIGHTENING:

Recommended tightening:
20 Ncm. Check tightening
torques and procedures on
pages 11-12.

IMPORTANT NOTE

To use these components it is necessary to have the B&B Dental libraries. You will find the software libraries in the "download" section of our site. Contact us for further support.

SPHERICAL ANCHORING SYSTEM

SPHERICAL ABUTMENTS

These abutments allow to stabilize mobile prosthesis in lower and upper jaws.

CHARACTERISTICS

- Setting off up to 20° divergence between two implants.
- Minimum height of the component, suitable for narrow occlusal space.
- Excellent long-term performance thanks to wear-resistant components.

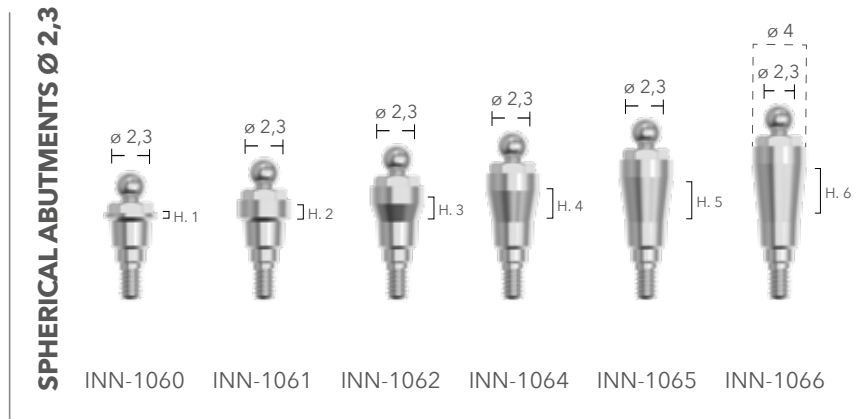

ACCESSORIES FOR IMPRESSION AND LAB



O-BALL ANALOG
INN-00623

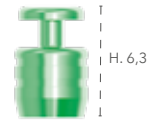

TRANSFER
INN-00625

Ø 2.3 PLASTIC CAPS AND METAL HOUSINGS

NOTE: The metal housing contains the plastic cap.

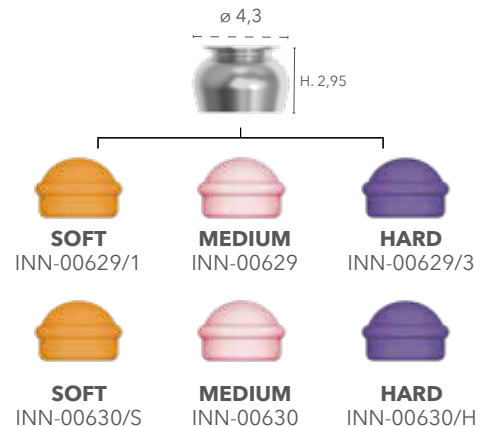

Ø 2.3 PLASTIC CAPS ONLY

6 pieces per package



+

OT EQUATOR

COMPLETE SET

- 1 Anchoring abutment
- 1 Stainless steel housing for caps
- 1 Violet cap -strong retention
- 1 White cap -standard retention
- 1 Pink cap -soft retention
- 1 Yellow cap -extrasoft retention
- 1 Black laboratory cap

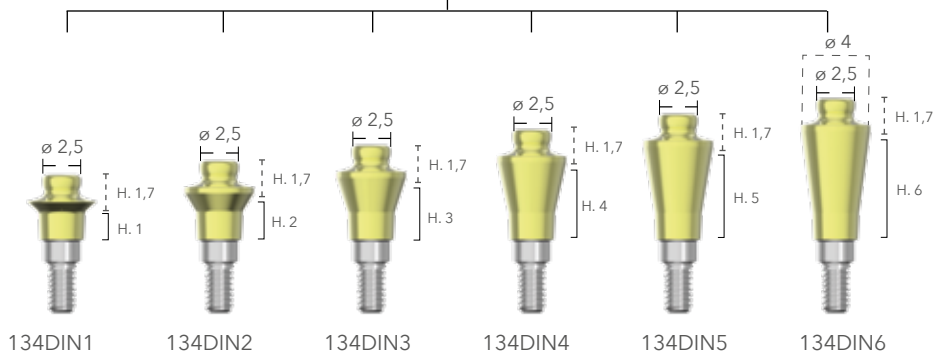

CAPS WITH METAL HOUSING



SMART BOX HOUSING WITH BLACK POSITIONING CAP
330SBE

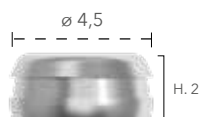

S/STEEL HOUSINGS
141CAE (2 pieces)



VIOLET CAPS (STRONG RETENTION)
140CEV (4 pieces)



WHITE CAPS (STANDARD RETENTION)
140CET (4 pieces)



PINK CAPS (SOFT RETENTION)
140CER (4 pieces)



YELLOW CAPS (EXTRASOFT RETENTION)
140CEG (4 pieces)

LAB ACCESSORIES*



LABORATORY BLACK CAPS
140CEN (4 pieces)

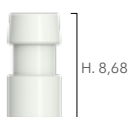

IMPRESSION COPINGS
144MTE (2 pieces)



LABORATORY ANALOGUES
144AE (2 pieces)



PULL-OFF IMPRESSION COPINGS
044CAIN (2 pieces)

SURGICAL INSTRUMENTS AND DRIVERS*



1 METAL INSERTION TOOL FOR CAPS
185IAC



1 BLUE PLASTIC "MULTIUSE" INSERTION TOOL
124ICP



1 SQUARE DRIVER CONNECTOR FOR CONTRA-ANGLE
760CE



1 OT EQUATOR SQUARE SCREWDRIVER FOR IMPLANT ABUTMENT (SQUARE 1,25 mm)
774CHE



TIGHTENING: Recommended tightening: 25 Ncm. check tightening torques and procedures on pages 11- 12.

03.

**REDUCED
DIAMETER
IMPLANTS**



REDUCED DIAMETER IMPLANTS



DURA-VIT SLIM implants have a reduced diameter and hence allow managing cases featuring limited bone crest by exploiting implants having a special surface and features, by B&B Dental. This line has its own very precise taper connection and includes dedicated surgical and prosthetic components, making the protocol intuitive.



DURA-VIT SLIM IMPLANTS

SLIM Ø3,4

HEX TAPER CONNECTION WITHOUT MORSE-TYPE TAPER

- Accurate positioning of prosthetic components
- Excellent choices, respecting parallelism
- Increased mating surface between implant and abutment
- High stability

COLLAR WITH REVERSE TAPER AND ANNULAR MICRO SPLINING

- Excellent support of soft tissues
- Maximum volume of alveolar bone
- Minor crestal bone resorption

SELF-TAPPING DOUBLE THREAD SPIRAL

- Sharp double thread for spiral tap increased depth
- Ensure easy insertion and osteocondensation
- Very high primary stability

PENETRATING TIP

- Allows the penetration in small diameter preparations
- Ideal anchoring

SLIM Ø3,0

COLLAR MICRO-THREADING

- Increases primary stability
- Makes implant placement easier
- Reduces vertical prosthesis load
- Helps soft tissue healing

TRIPLE-THREAD SPIRAL

- 60° bevelled profile threading
- Increases mating surface with bone to ensure less invasive procedures
- Improves osseointegration

NARROW TIP

- Not suitable for sites close to the nerve or sinus membrane.

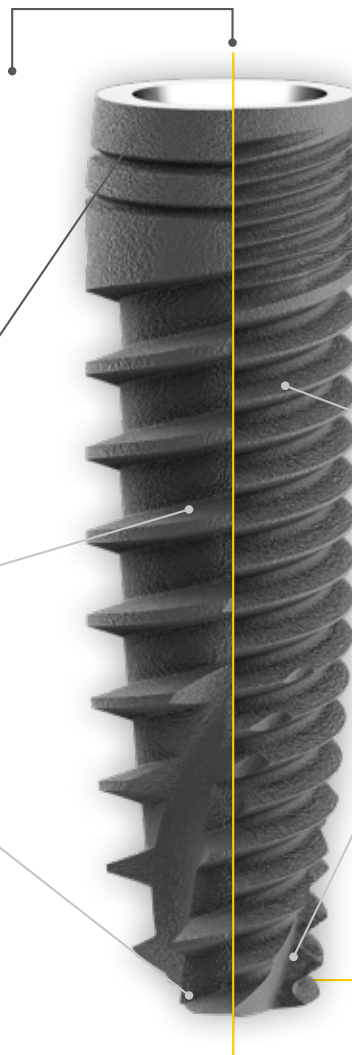

PROPERTIES









SLIM Ø 3,4 IMPLANT

- Ideal in spongy bone (D3-D4).
- Allows condensation.
- Ideal in post-extraction sites.
- Grade 4 Titanium.

SLIM Ø 3,0 IMPLANT

- Excellent in all bone types (especially D1-D2).
- Ensure high primary stability.
- Not ideal in sites next to sinus or nerve.
- Grade 5 Titanium.

SLIM • LINE

	L. 8	L. 10	L. 12	L. 14
ø 3,4	 SL-3408	 SL-3410	 SL-3412	 SL-3414
ø 3	 3P-3008	 3P-3010	 3P-3012	 3P-3014

These codes include the locking screw

IMPORTANT NOTE

DURA-VIT SLIM ø3.4 and ø3 require the same prosthetic components. Please notice that they are different from the EV, 3P, WIDE and PTERYGO implant lines. The screw secondary component and the analogues of this line are different from those of the EV, 3P, WIDE and PTERYGO lines.



IMPRESSION & HEALING COMPONENTS

HEALING SCREW (grade 5 titanium)

These components are used to rehabilitate soft tissues around the implant so that the final abutment can be later placed.

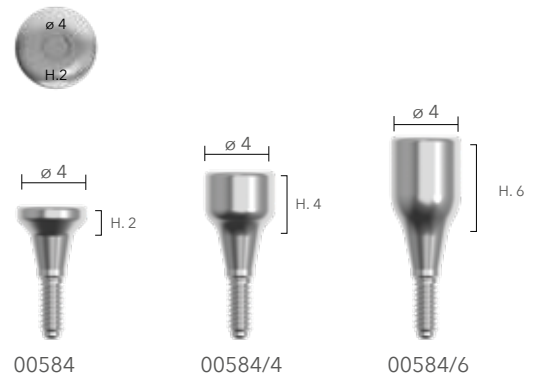

FACILITY TRANSFER

For use of the standard tray holder with closed-tray technique, by tightening the transfer coping in the implant and positioning the plastic cap in place it will be possible to obtain a clear positioning in the impression.



PICK-UP TRANSFER

To be used with open tray holders, with open-tray technique, by screwing the transfer inside the implant it will be possible to obtain a clear positioning in the impression.

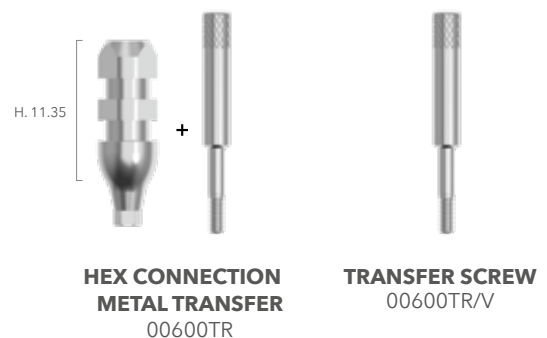

ANALOG

Analogues reproduce the implant shape and connection inside the model. They must be carefully placed on the transfers inside the impression before proceeding with model pouring.

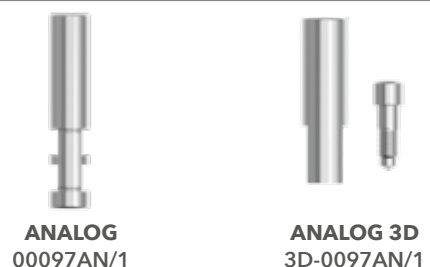

PROSTHETIC COMPONENTS

TITANIUM ABUTMENTS Ø 4

They are titanium components mainly used for cemented prosthesis in the front areas. These abutments DO NOT have a taper coupling.

CHARACTERISTICS

- Reduced need for touching-ups thanks to prepared mucosal margins.
- Different transmucosal heights to adapt to various profiles.
- Cylindrical shape similar to the emerging profile of a natural tooth.



TIGHTENING:

Recommended tightening 25 Ncm.
Check tightening torques and procedures on pages 11-12.

IMPORTANT NOTE

Proper position of angled abutments can be checked by ensuring that the driver external hexagon is aligned with the internal hexagon.

This code includes screw 00358/V

STRAIGHT Ø 4

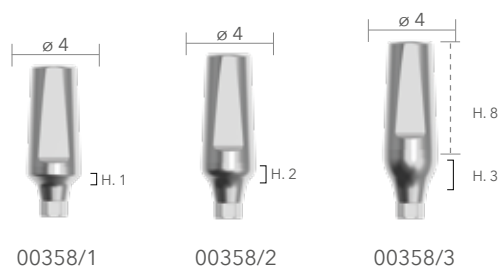

00358/1

00358/2

00358/3

This code includes screw 00358/V

ANGLED 15° Ø 4

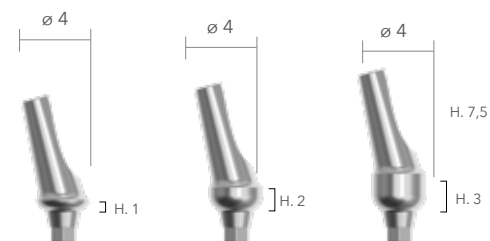

00370/14

00370/15

00370/16

This code includes screw 00358/V

ANGLED 25° Ø 4

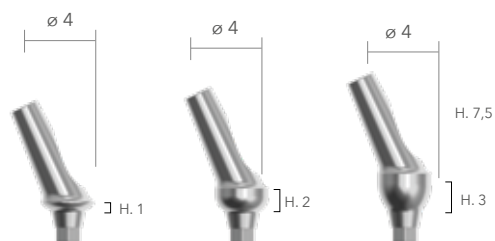

00371/24

00371/25

00371/26



00358/V

TEMPORARY ABUTMENT IN PEEK

These abutments have been designed as temporary abutments

CHARACTERISTICS

- Utmost adaptability.
- Possibility of customising the emerging profile and adaptation to gum edge profile to obtain excellent aesthetic results.

This code includes screw 00358/V

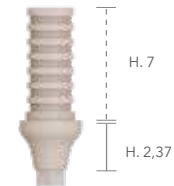

SL-2081P

CASTABLE ABUTMENT Ø 4

These abutments must be used with the lost-wax procedure.

CHARACTERISTICS

- Utmost adaptability.
- Possibility of customising the emerging profile and adaptation to gum edge profile to obtain excellent aesthetic results.

This code includes screw 00358/V

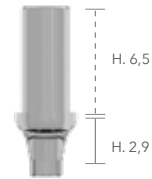

00358CA

SLIM DIGITAL TOOLS

TI BASE CEREC® (S LINE)

They are titanium components used for cemented prosthesis and tightened using digital technologies.

These abutments have a taper coupling.

CHARACTERISTICS

- Titanium base.
- Completely customisable prosthesis.
- Use of CAD/CAM technology to produce zirconium abutments to be glued onto the central abutment.

This code includes screw 00358/V

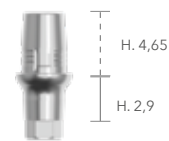

00655



*

*Distributed by B&B Dental



00358/V



TIGHTENING:

Recommended tightening 20 Ncm. Check tightening torques and procedures on pages 11- 12

NOTE:

Scanbody items are placed on ScanPost and TiBase for implant data optical acquisition. The grey cap is used with the omnicam system. The white cap is used with the bluecam system. Two connections are available:

- S compatible for SLIM (codes: 6431295 -6431311)
- L - compatible for conexa line (codes: 6431303 - 6431329)

SCAN SLIM COMPONENTS

The digital components are specifically designed to be used with scanner and printer. Please send us an e-mail to receive the libraries.

TI LINK SLIM

They are titanium components mainly used for cemented prosthesis with digital technologies.

CHARACTERISTICS

- Reduced need for touching-ups thanks to the prepared mucosal margins.
- Different transmucosal heights to adapt to various profiles.
- Cylindrical shape similar to the emerging profile of a natural tooth.

CASTABLE CYLINDER



SL-0524

PREMILLED BASES

Premilled are bases for the construction of customised milled abutments. These components are characterised by a connection certified by B&B Dental.

3D ANALOGUES

3D analogues can be fixed in the printed models in which they are placed.

IMPORTANT NOTE

To use these components it is necessary to have the B&B Dental libraries. You will find the software libraries in the "download" section of our site. Contact us for further support.

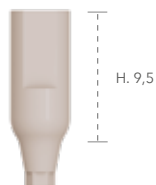

LONG SCANBODY
SL-SCAN-2-NR

This code includes screw 00358/V



00358/V

NON-ROTATING BASE

This code includes screw 00358/V



00652

00652/1

00652/2

00652/3

ROTATING BASE

This code includes screw 00358/V

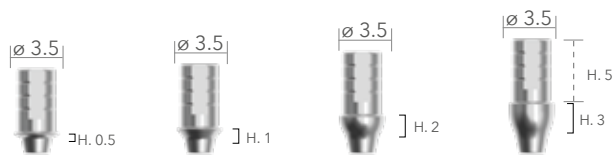

00652/R

00652/1R

00652/2R

00652/3R

PREMILLED MEDENTIKA

This code includes screw 00358/V

also available upon request for NT-trading and Des holreds



SL-CF2122 Ti
SL-CB2122 Cr-Co



SL-CF2124 Ti
SL-CB2124 Cr-Co

This code includes screw 3D-02



3D SLIM ANALOG
3D-0097AN/1

FLAT ANCHORING SYSTEM

FLAT ABUTMENTS

The flat abutments directly screw onto the implant and are ideal for the reconstruction of complete arches since their design ensures flexibility in a clinical situation where implants are not parallel, keeping the withdrawal axis not beyond 15° for convergent and divergent implants. These abutments simulate the external connection.

- Screw-retained prosthesis.
- Bar-type prosthesis on implants.
- Immediate installation.

CHARACTERISTICS

- Allow production of stable prosthesis
- Suitable for aesthetic areas.

IMPORTANT NOTE

Do not use whenever implant divergence exceeds 15°.

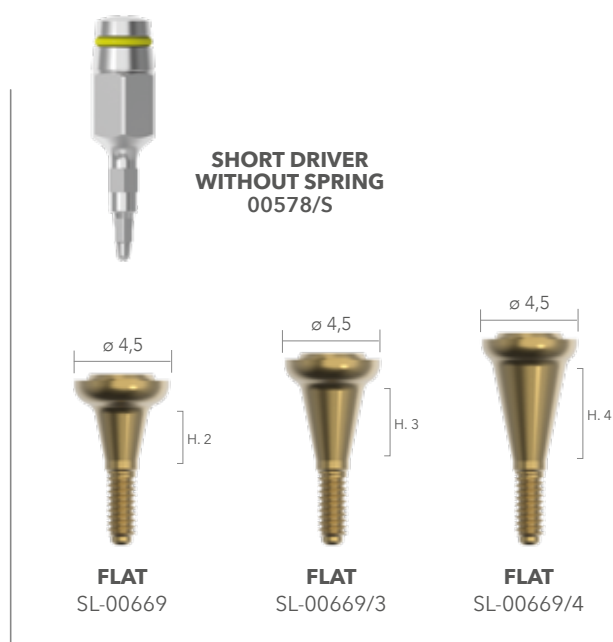

HEALING SCREW

It is used for mucosal healing and conditioning, on top of FLATs. These components are used to rehabilitate soft tissues above the implant so that the final prosthetic abutment can be placed.



TRANSFERS

The transfer must be placed onto the FLAT to accurately adjust the position. In this case, use the FLAT analogue.



ANALOGUES

Analogues reproduce the implant shape and connection inside the model. They must be carefully placed on the transfers inside the impression before proceeding with model pouring.



ABUTMENTS FOR FLAT

These abutments must be fixed onto the FLATSs to build structures.

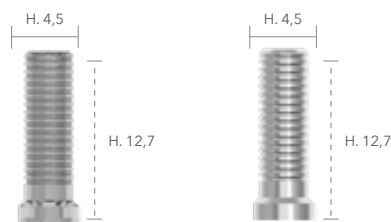

**CASTABLE
ABUTMENT
INN-00687**
This code includes
screw INN-00690

**TITANIUM
ABUTMENT
INN-00687/1**
This code includes
screw INN-00690

FLAT DIGITAL TOOLS

The digital components are specifically designed to be used with scanner and printer. Please Send us an e-mail to receive the libraries.

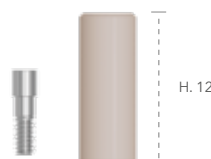

**SCAN FLAT
SCAN-FLAT**
This code includes screw INN-00690

SCAN FOR FLAT

The FLAT scan is a rotating tool to take impressions by means of intraoral or laboratory scanners.



**FLAT BASE
3D-00687/2**
This code includes screw INN-00690

TI LINK BASES FOR FLAT

FLAT bases are useful for anchoring crowns above FLATS, since there is no geometric index they are rotating bases.

TI LINK BASES FOR FLAT FOR INCLINED HOLE

It is provided to allow the creation of crowns featuring an angled screw hole.



The base code 3D-00687/1 can be used for inclined holes, by separately purchasing screw code 3D-16

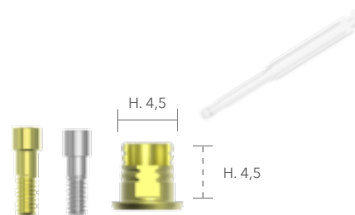

**FLAT BASE FOR INCLINED HOLES
3D-00687/1**
This code includes screw INN-00690

3D ANALOGUES

3D analogues can be fixed in the printed models in which they are placed.



**FLAT 3D ANALOG
3D-00736**
This code includes screw 3D-02



TIGHTENING:

Recommended tightening 15 Ncm. Check tightening torques and procedures on pages 11-12.

IMPORTANT NOTE

To use these components it is necessary to have the B&B Dental libraries. You will find the software libraries in the "download" section of our site. Contact us for further support.

SPHERICAL ANCHORING SYSTEM

SPHERICAL ABUTMENTS

These abutments allow the stabilization of removable prosthesis in lower and upper jaws.

Moreover, special surgical instruments are required, also suitable for placing the DURA-VIT MINI IMPLANT.

CHARACTERISTICS

- Setting off up to 20° divergence between two implants.
- Minimum height of the component, suitable for narrow occlusal space.
- Excellent long-term performance thanks to wear-resistant components.

SPHERICAL ABUTMENTS Ø 1,8

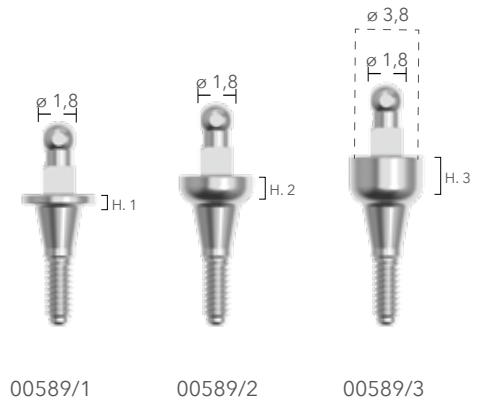

LABORATORY AND SURGICAL INSTRUMENTS



BUTTERFLY KEY
MD-3002



KEY FOR TORQUE RATCHET (Short)
MD-3003S



KEY FOR TORQUE RATCHET (Long)
MD-3003L



SPHERICAL ANALOG
MD-3007

Ø 1.8 PLASTIC CAP AND METAL HOUSINGS

Three different retention levels are available for prosthesis matrices, which are obtained by using special O-rings and metal matrices.

NOTE: The metal housing is sold separately, without any plastic cap inside.

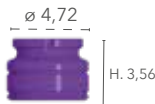

SOFT RETENTION
MD-3004/1



MEDIUM RETENTION
MD-3004

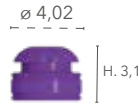

HARD RETENTION
MD-3004/2



O-RING (LARGE)
MD-3005/1 (5 pieces)



O-RING (SMALL)
MD-3005 (5 pieces)



ELASTIC
049PCM (6 pieces)



SOFT
040CRM SN (6 pieces)



EXTRA SOFT
060CRM AY (6 pieces)



METAL HOUSING
041CAM (2 pieces)



+

OT EQUATOR

COMPLETE SET

- 1 Anchoring abutment
- 1 Stainless steel housing for caps
- 1 Violet cap -strong retention
- 1 White cap -standard retention
- 1 Pink cap -soft retention
- 1 Yellow cap -extrasoft retention
- 1 Black laboratory cap

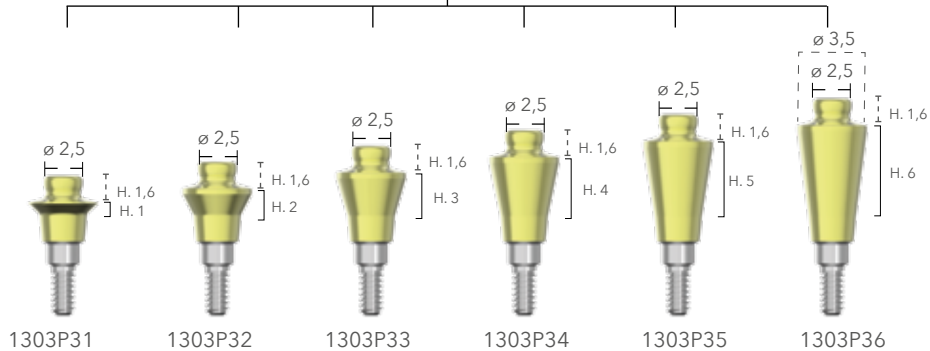

CAPS WITH METAL HOUSING



SMART BOX HOUSING WITH BLACK POSITIONING CAP
330SBE

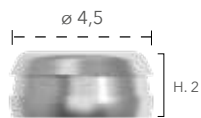

S/STEEL HOUSINGS
141CAE (2 pieces)



VIOLET CAPS (STRONG RETENTION)
140CEV (4 pieces)



WHITE CAPS (STANDARD RETENTION)
140CET (4 pieces)



PINK CAPS (SOFT RETENTION)
140CER (4 pieces)



YELLOW CAPS (EXTRASOFT RETENTION)
140CEG (4 pieces)

LAB ACCESSORIES



LABORATORY BLACK CAPS
140CEN (4 pieces)

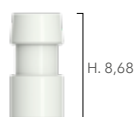

IMPRESSION COPINGS
144MTE (2 pieces)



LABORATORY ANALOGUES
144AE (2 pieces)



PULL-OFF IMPRESSION COPINGS
044CAIN (2 pieces)

SURGICAL INSTRUMENTS AND DRIVERS



1 METAL INSERTION TOOL FOR CAPS
185IAC



1 BLUE PLASTIC "MULTIUSE" INSERTION TOOL
124ICP



1 SQUARE DRIVER CONNECTOR FOR CONTRA-ANGLE
760CE



1 OT EQUATOR SQUARE SCREWDRIVER FOR IMPLANT ABUTMENT (SQUARE 1,25 mm)
774CHE



TIGHTENING:

Recommended tightening 20 Ncm. Check tightening torques and procedures on pages 11-12.

MINI IMPLANTS

The DURA-VIT implant line is equipped with implant solutions for most of the clinical implantology needs.

Mini implants are single-phase implants with an integrated spherical or cubic prosthetic connection that can be used to stabilise removable prostheses or to rehabilitate single teeth in areas of limited space.

These implants are equipped with dedicated instruments and components for both manual and guided insertion.





04.

MINI IMPLANTS









DURA-VIT MINI BALL HEAD AND SQUARE HEAD





PROPERTIES

- They allow positioning in areas of limited space.
- Ideal for stabilising removable prostheses and for single teeth
- Can be used with immediate load.
- Grade 5 Titanium.

MINI • LINE

	L. 10	L. 13	L. 15
ø 2	 MD/20/10	 MD/20/13	 MD/20/15
ø 2.4	 MA/24/10 MD/24/10	 MA/24/13 MD/24/13	 MA/24/15 MD/24/15

COLOUR CODING OF INTERNAL TUBE IMPLANTS AND TOOLS

MINI LINE colour code	 ø 2,0	 ø 2,4
Final drill diameter	ø 2,0	ø 2,4

PROSTHETIC COMPONENTS FOR BALL HEAD

ANALOG

Analogues reproduce the implant shape and connection inside the model. They must be carefully placed on the transfers inside the impression before proceeding with model pouring.



SPHERICAL ANALOG
MD-3007

TRANSFER

The transfer is applied onto the abutment of mini spherical implants for precise adjustment of the position.



IMPRESSION COPINGS
MD-3014

STRAIGHT ABUTMENTS

These abutments are specially designed to fit the spherical head of the implants belonging to the mini line with spherical head.



TEMPORARY CAP
MD-3013

STRAIGHT ABUTMENTS
MD-3010

PVC PROTECTION

The protection prevents resin from seeping into the cap during the incorporation of the caps into the prosthesis.



PVC PROTECTION
MD-3008

Ø 1.8 PLASTIC CAPS AND METAL HOUSINGS

Three different retention levels are available for prosthesis matrices, which are obtained by using special O-rings and metal matrices.

NOTE: The metal prosthesis matrix is sold separately, without any plastic cap inside.

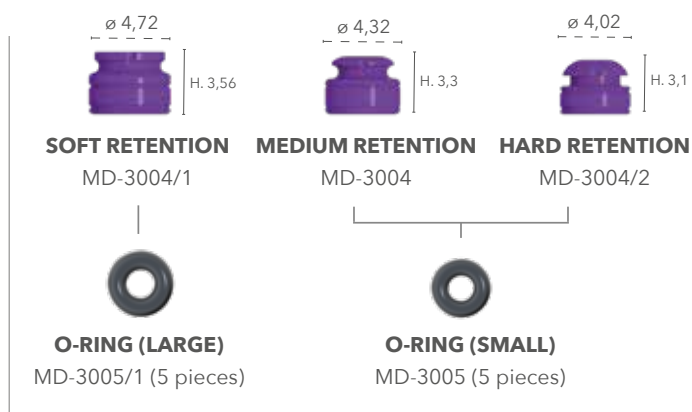

PROSTHETIC COMPONENTS FOR QUADRA HEAD

ANALOG

Analogues reproduce the implant shape and connection inside the model. They must be carefully placed on the transfers inside the impression before proceeding with model pouring.



SQUARE ANALOG
MA-1007

SQUARE HEAD TRANSFER/CASTABLE

It has two functions: transfer and castable abutment for implant position adjustment and implant prosthesis application.



CASTABLE
MD-3006

SURGICAL INSTRUMENTS & KITS

The study and care put into the production of implants are also applied to the design of surgical instruments. Although they are also sold separately, B&B Dental has prepared pre-set surgical kits, dedicated to the main techniques of the DURA-VIT line, to guarantee that the clinician has always the necessary instruments at the right time.

Please note that surgical instruments must be stored with care, tested for proper operation and wear, and periodically evaluated for replacement to keep them in optimal working order and ensure they are safe.





05.

INSTRUMENTS & KITS



COMPLETE SURGICAL KIT FOR 3P/EV/SL -DURA-VIT LINE

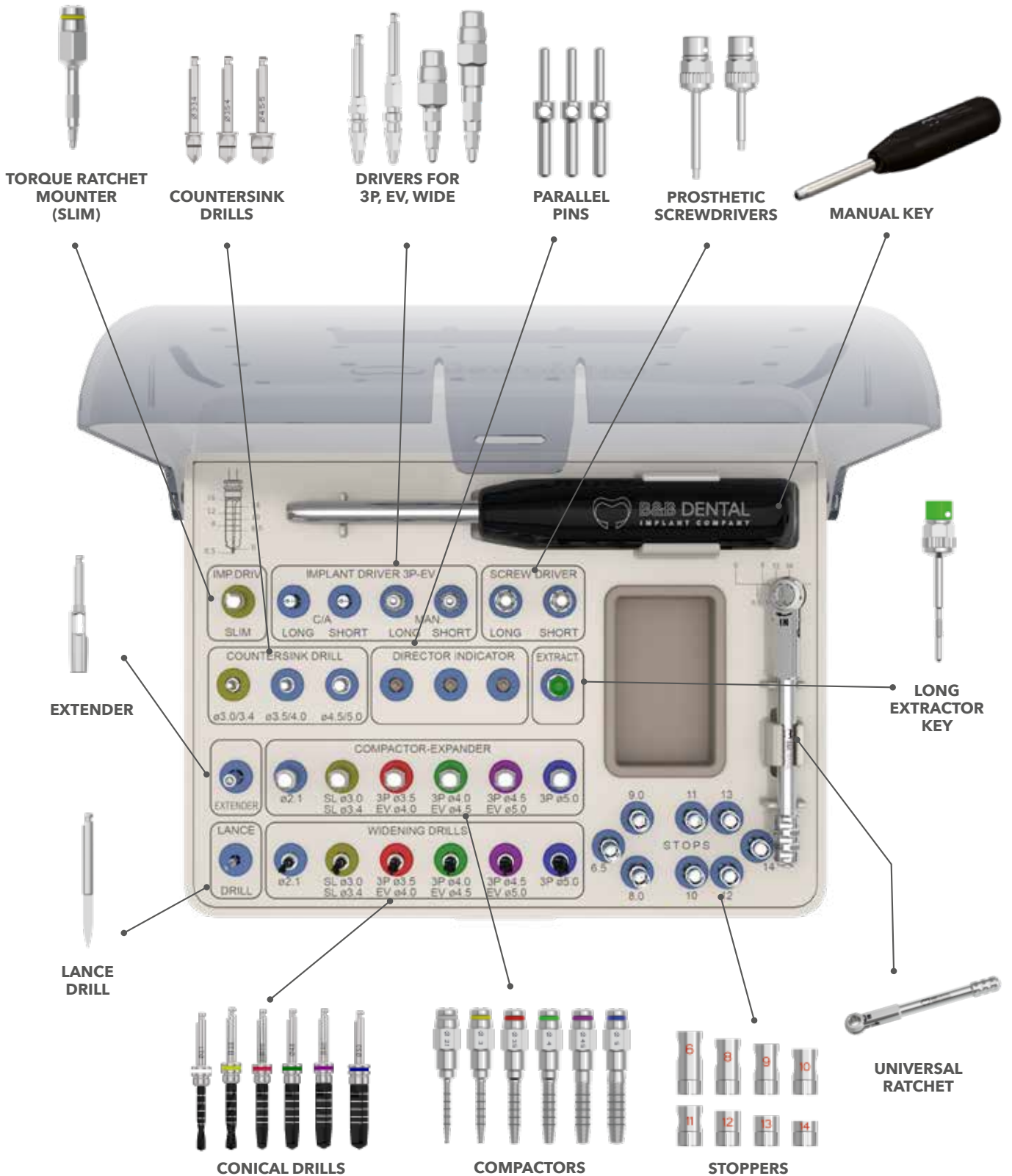



REF. 3P-00092SC

Extender	Ref. 00236N	Metal stopper L. 8,0 mm	Ref. STOP01
Lance drill	Ref. 147-021	Metal stopper L. 9,0 mm	Ref. STOP07
Drill Ø 2,1	Ref. 00074CUT	Metal stopper L. 10 mm	Ref. STOP02
Conical drill Ø 3,0	Ref. 00075CUT	Metal stopper L. 11 mm	Ref. STOP08
Conical drill Ø 3,5	Ref. 3P-35CUT	Metal stopper L. 12 mm	Ref. STOP03
Conical drill Ø 4,0	Ref. 3P-40CUT	Metal stopper L. 13 mm	Ref. STOP09
Conical drill Ø 4,5	Ref. 3P-45CUT	Metal stopper L. 14 mm	Ref. STOP04
Conical drill Ø 5,0	Ref. 3P-50CUT	Parallel pins (3 pcs)	Ref. 00441T
Compactor-expander Ø 2,1	Ref. 201-3P	Slim implant driver (Long)	Ref. 00578/L
Compactor-expander Ø 3,0	Ref. 281-3P	Implant contra-angle key (Short)	Ref. INN-00581
Compactor-expander Ø 3,5	Ref. 331-3P	Implant contra-angle key (Long)	Ref. INN-00581/L
Compactor-expander Ø 4,0	Ref. 381-3P	Implant driver (Long)	Ref. INN-00590/2
Compactor-expander Ø 4,5	Ref. 431-3P	Implant driver (Short)	Ref. INN-00590/1
Compactor-expander Ø 5,0	Ref. 481-3P	Prosthetic screwdriver (Long)	Ref. INN-61000L
Countersink drill Ø 3,0/3,4	Ref. NECK-334	Prosthetic screwdriver (Short)	Ref. INN-61000
Countersink drill Ø 3,5/4,0	Ref. NECK-354	Universal ratchet	Ref. 00376
Countersink drill Ø 4,5/5,0	Ref. NECK-455	Manual key	Ref. 3P-00090CM
Metal stopper L. 6,5 mm	Ref. STOP06	Extractor key (Long)	Ref. INN-6161L



SIMPLIFIED SURGICAL KIT FOR 3P/EV/SL -DURA-VIT LINE

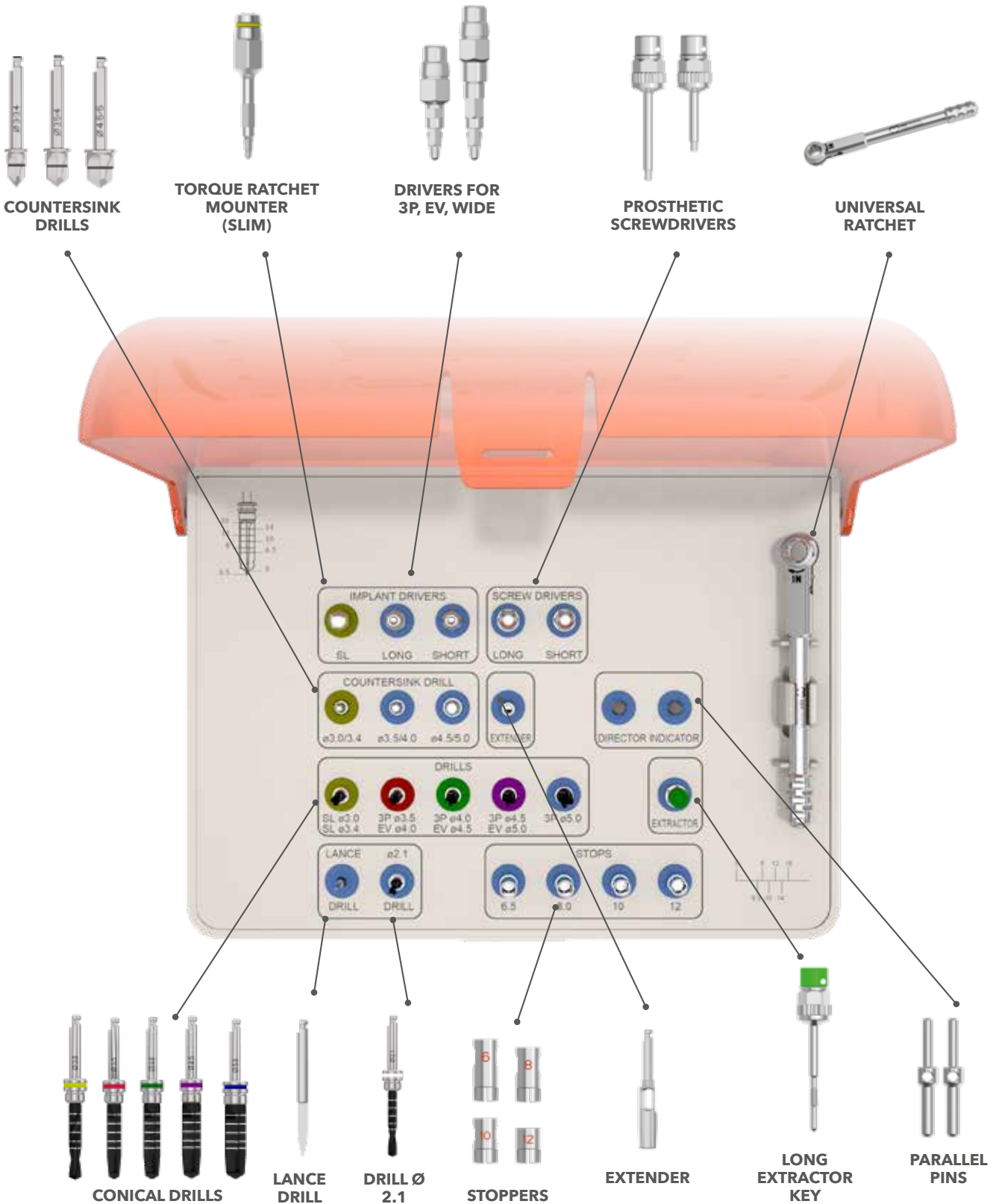



REF. 3P-00095SC

Lance drill	Ref. 147-021	Countersink drill Ø 3,0/3,4	Ref. NECK-334
Drill Ø 2,1	Ref. 00074CUT	Countersink drill Ø 3,5/4,0	Ref. NECK-354
Metal stopper L. 6,5 mm	Ref. STOP06	Countersink drill Ø 4,5/5,0	Ref. NECK-455
Metal stopper L. 8,0 mm	Ref. STOP01	Slim implant driver (Long)	Ref. 00578/L
Metal stopper L. 10,00 mm	Ref. STOP02	Implant driver (Long)	Ref. INN-00590/1
Metal stopper L. 12,00 mm	Ref. STOP03	Implant driver (Short)	Ref. INN-00590/2
Conical drill Ø 3,0	Ref. 00075CUT	Prosthetic screwdriver (Long)	Ref. INN-61000L
Conical drill Ø 3,5	Ref. 3P-35CUT	Prosthetic screwdriver (Short)	Ref. INN-61000
Conical drill Ø 4,0	Ref. 3P-40CUT	Extractor key (Long)	Ref. INN-6161L
Conical drill Ø 4,5	Ref. 3P-45CUT	Parallel pins (2 pcs)	Ref. 00441T
Conical drill Ø 5,0	Ref. 3P-50CUT	Universal ratchet	Ref. 00376
Extender	Ref. 00236N		



KIT FOR PTERYGO IMPLANTS

FOR PTERYGO -DURA-VIT LINE

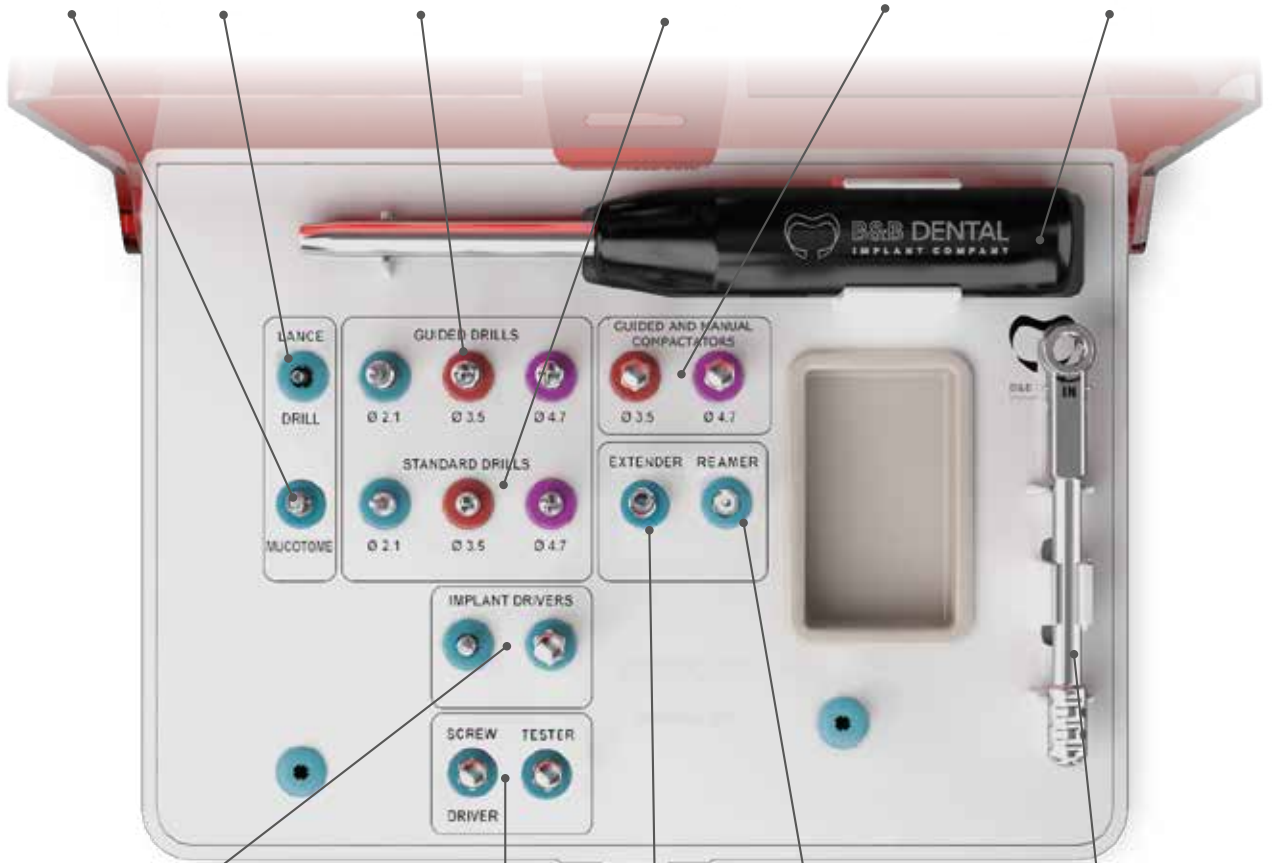
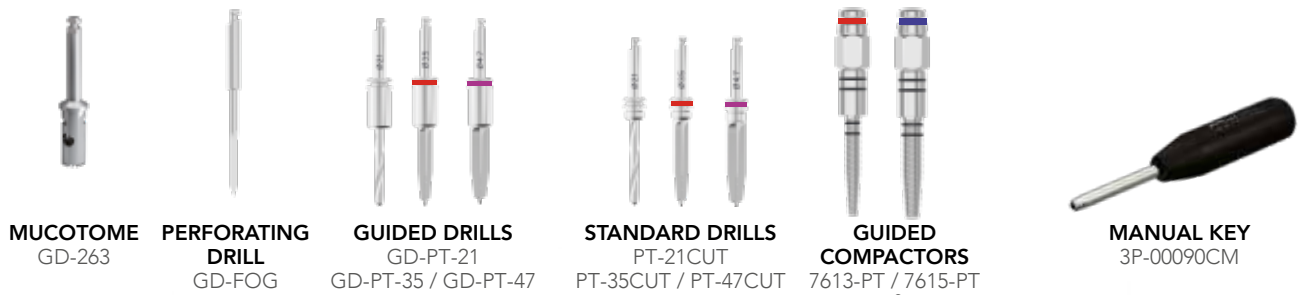



REF. PT-00092SC

Prosthetic key for pterygo system ratchet	Ref. PT-01	Guided compactors Ø 3	Ref. 7613-PT
Probe key for pterygo system ratchet	Ref. PT-02	Guided compactors Ø 4,7	Ref. 7615-PT
Pterygoid guided drill Ø 2,1	Ref. GD-PT-21	Manual inserter	Ref. 3P-00090CM
Pterygoid guided drill Ø 3,5	Ref. GD-PT-35	Mucotome	Ref. GD-263
Pterygoid guided drill Ø 4,7	Ref. GD-PT-47	Perforating drill	Ref. GD-FOG
Pterygoid drill Ø 2,1	Ref. PT-21CUT	Ratchet driver	Ref. INN-00590/2
Pterygoid drill Ø 3,5	Ref. PT-35CUT	Contra-angle key	Ref. INN-00581/L
Pterygoid drill Ø 4,7	Ref. PT-47CUT	Extender	Ref. 00236N
		Reamer	Ref. GD-BM
		Universal ratchet	Ref. 00376

CRESTAL SINUS LIFT KIT

DURA-VIT LINE

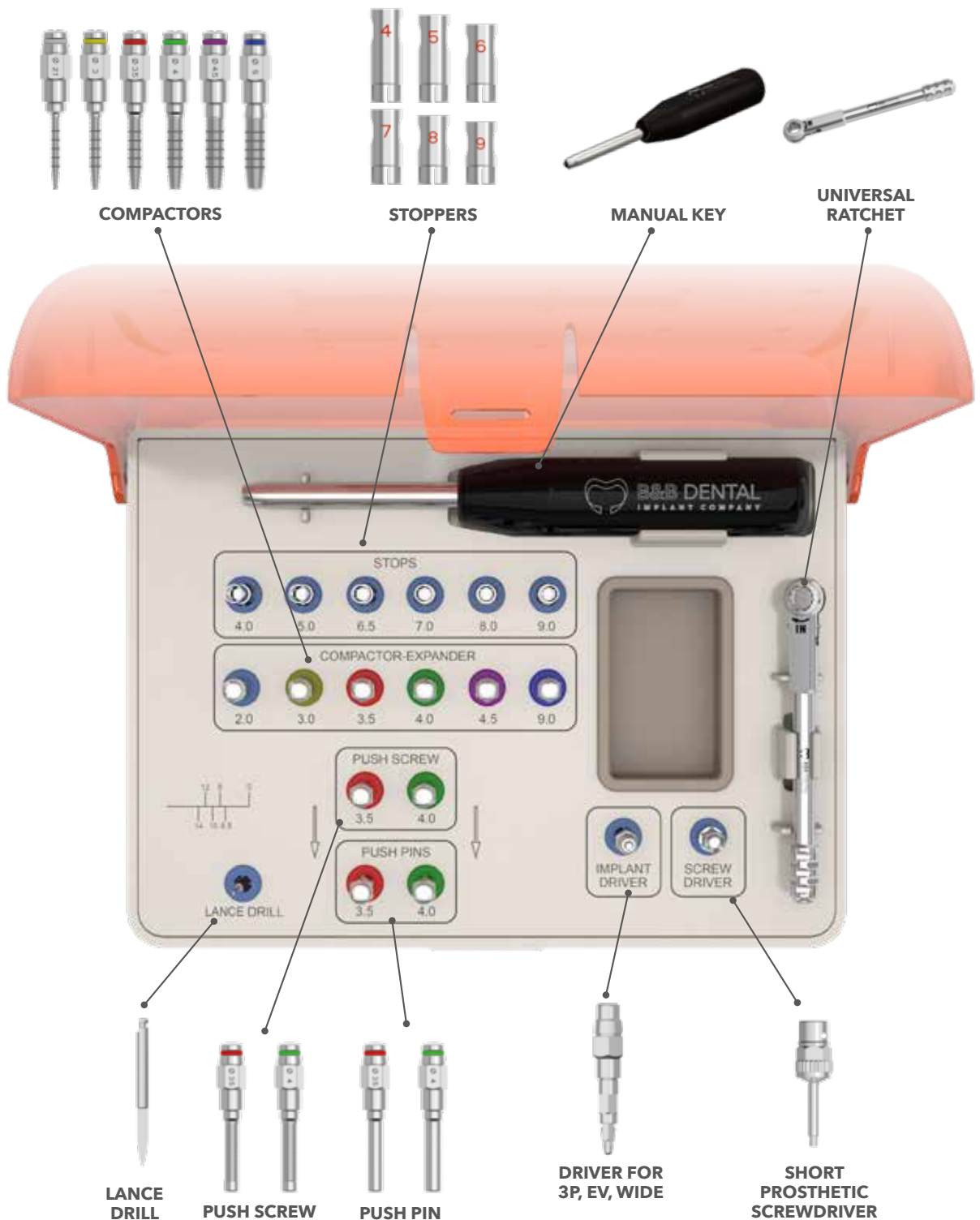



REF. 3P-00093SC

Lance drill	Ref. 147-021	Metal stopper L. 8,0 mm	Ref. Stop01
Compactor-expander Ø 2,1	Ref. 201-3P	Metal stopper L. 9,0 mm	Ref. Stop07
Compactor-expander Ø 3,0	Ref. 281-3P	Push pin Ø 3,5	Ref. SL-PP35
Compactor-expander Ø 3,5	Ref. 331-3P	Push pin Ø 4,0	Ref. SL-PP40
Compactor-expander Ø 4,0	Ref. 381-3P	Push screw Ø 3,5	Ref. SL-PS35
Compactor-expander Ø 4,5	Ref. 431-3P	Push screw Ø 4,0	Ref. SL-PS40
Compactor-expander Ø 5,0	Ref. 481-3P	Torque ratchet mounter (Long)	Ref. INN-00590/2
Metal stopper L. 4,0 mm	Ref. Stop12	Manual key	Ref. 3P-00090CM
Metal stopper L. 5,0 mm	Ref. Stop05	Prosthetic screwdriver (Short)	Ref. INN-61000
Metal stopper L. 6,5 mm	Ref. Stop06	Universal ratchet	Ref 00376
Metal stopper L. 7,0 mm	Ref. Stop11		



WIDE SURGICAL KIT

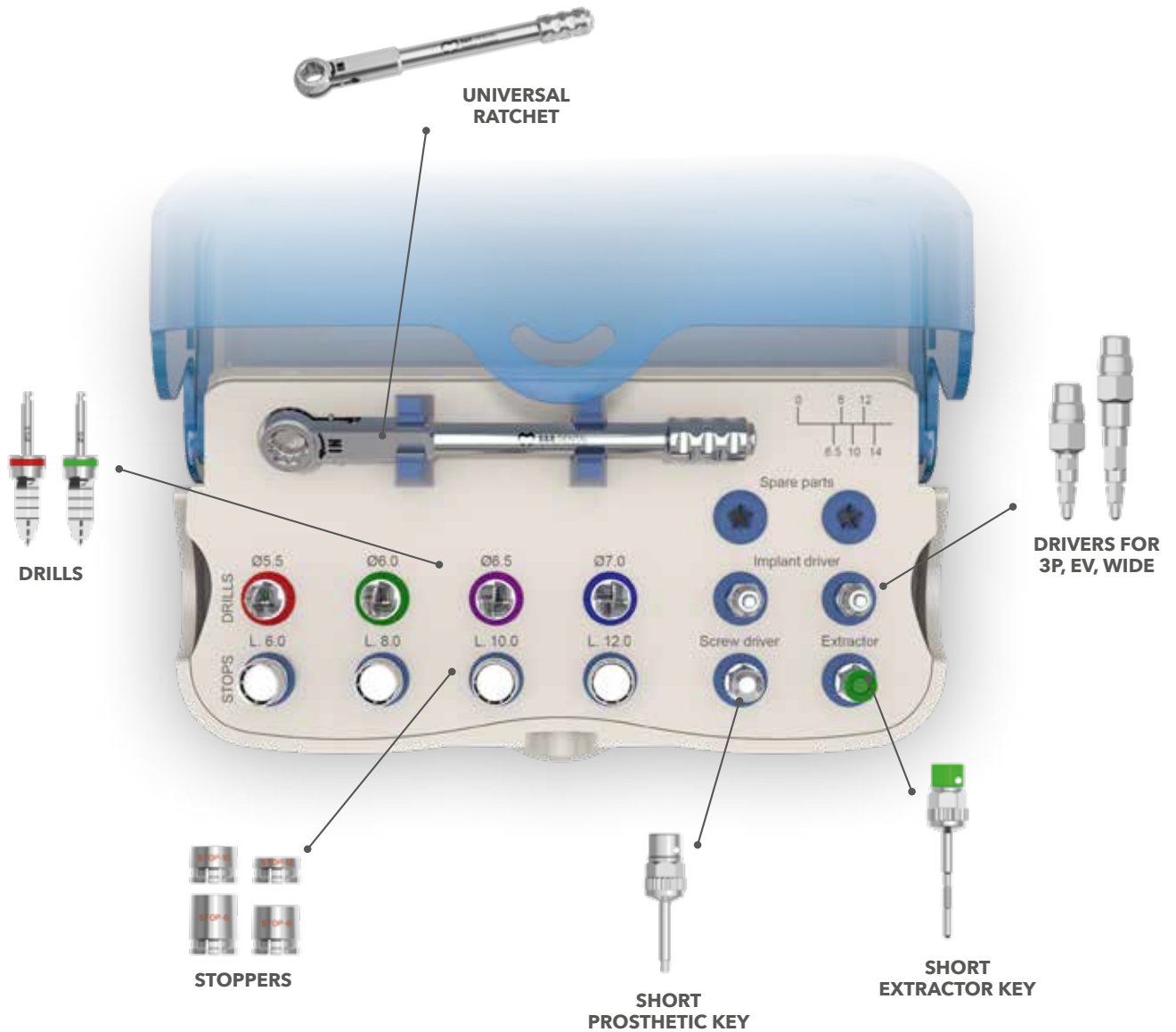

REF. WIDE-00092SC

WIDE drill Ø 5,5

Ref. WIDE-55CUT

WIDE drill Ø 6,0

Ref. WIDE-60CUT

WIDE Metal stopper L. 6,5 mm

Ref. W-STOP06

WIDE Metal stopper L. 8,0 mm

Ref. W-STOP08

WIDE Metal stopper L. 10 mm

Ref. W-STOP10

WIDE Metal stopper L. 12 mm

Ref. W-STOP12

Extractor Key (Short)

Ref. INN-6161

Implant driver (Short)

Ref. INN-00590/1

Implant driver (Long)

Ref. INN-00590/2

Prosthetic screwdriver (Short)

Ref. INN-61000

Universal ratchet

Ref. 00376

PROSTHETIC KIT

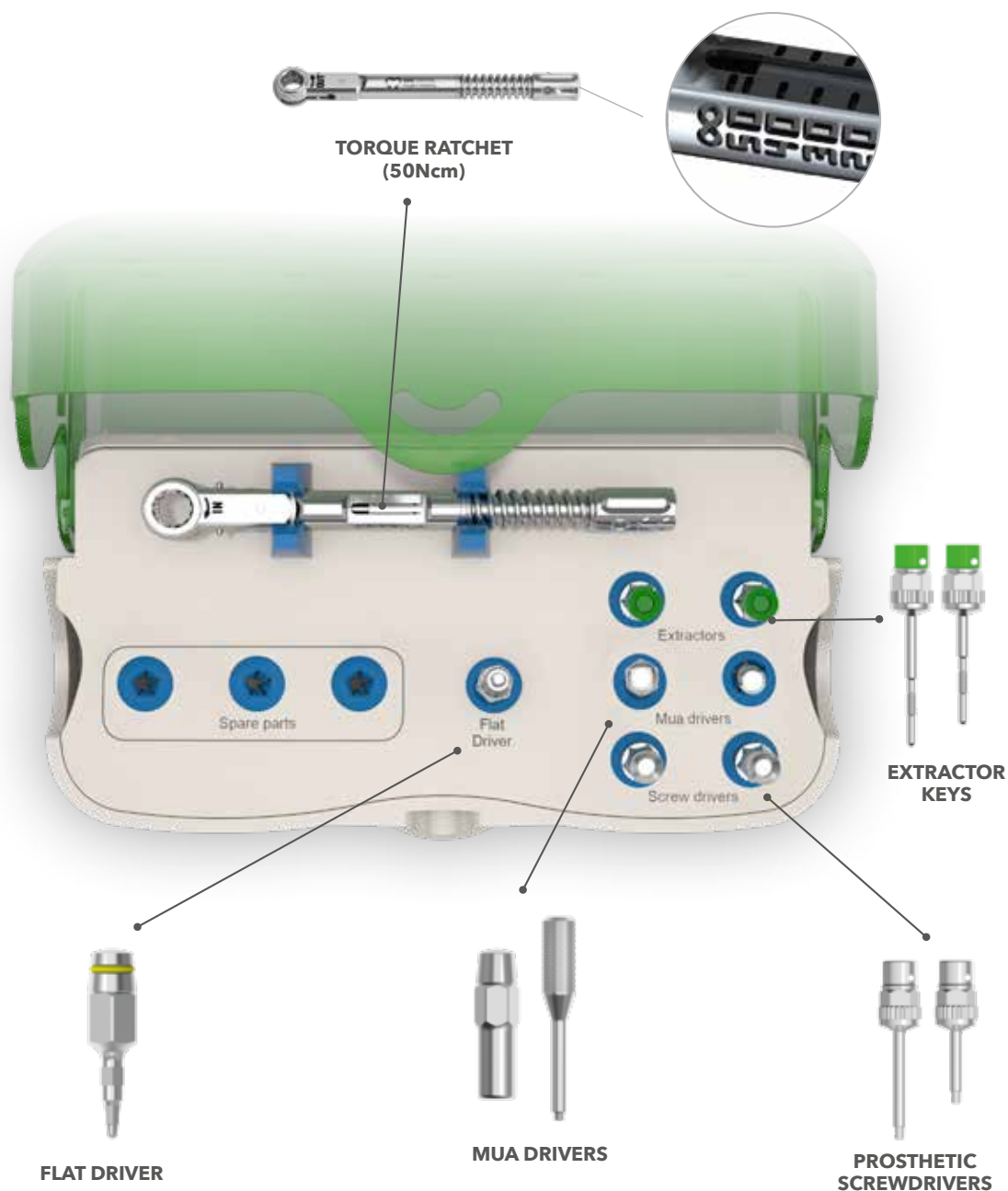

REF. KITPROTESICO

Torque ratchet (50 Ncm)	Ref. 00376DIN	Prosthetic screwdriver (Long)	Ref. INN-61000
Flat driver	Ref.00578/S	Prosthetic screwdriver (Short)	Ref. INN-61000L
Straight MUA torque ratchet driver	Ref. INN-00637	Extractor Key (Long)	Ref. INN-6161L
Angled MUA positioner	Ref. 023-MUA	Extractor Key (Short)	Ref. INN-6161



DURA-VIT MINI IMPLANT KIT

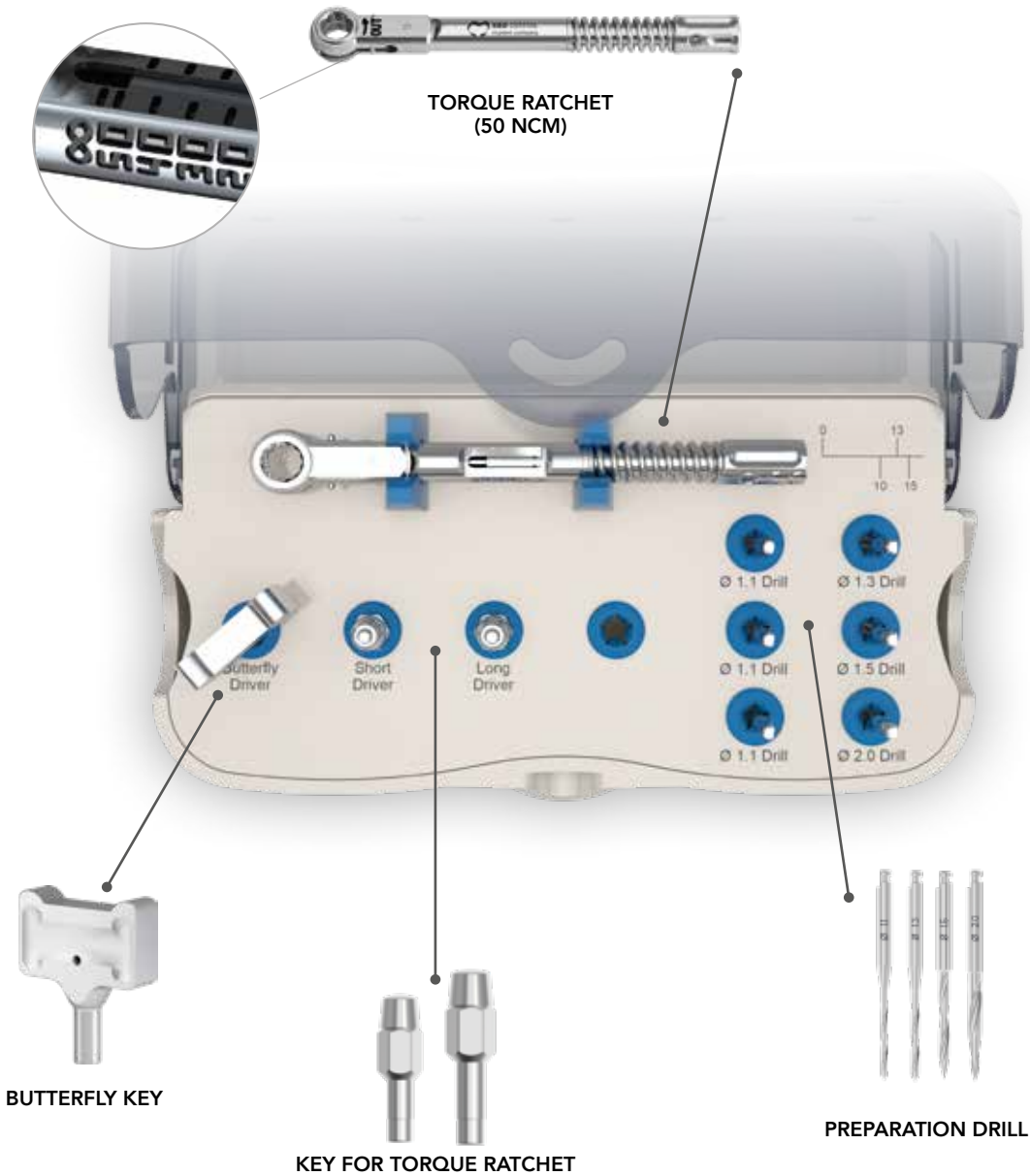

REF. 00075SC

Torque ratchet (50ncm)

Ref. 00376DIN

Preparation drill Ø 1,1

Ref. MD-3001/11

Preparation drill Ø 1,3

Ref. MD-3001/13

Preparation drill Ø 1,5

Ref. MD-3001

Preparation drill Ø 2

Ref. MD-3001/2

Key for torque ratchet (short)

Ref. MD-3003S

Key for torque ratchet (long)

Ref. MD-3003L

Butterfly key

Ref. MD-3002



SURGICAL COMPONENTS



Surgical components are also sold in bulk to enable the continued use of the kits and allow for the purchase of individual instruments not included in the standard equipment.

The majority of instruments are identified by a colour-coding for diameter size and are laser-marked for identification and depth.

All instruments have been specially designed for the implants of the DURA-VIT line.



SURGICAL COMPONENTS

SURGICAL INSTRUMENTS

Parallel pins help drills aiming once inserted into the surgically prepared implant site.

The **Mucotomes**, used with low-speed contra-angle, allow piercing the mucosa according to the diameter of the chosen implant.

The **Templates** help the surgeon in choosing the right implant during the planning stage using the panoramic X-rays. The whole range of DURA-VIT 3P implants is shown in 2 size scales: a real one and another one zoomed in at 25%, considering panoramic X-ray distortions.



IMPORTANT NOTE

Use the extender only for drills, DO NOT use for implant insertion.

INITIAL DRILLS

EXTENDER DRILL

It increases the drilling depth during surgery.

LANCE DRILL

It creates the implant insertion point and is used to penetrate the cortical bone plates to assess bone quantity and quality.

ROUNDED DRILL

Prepares the cortical bone plate at implant neck level.



PROSTHETIC SCREWDRIVERS

- Hex screwdriver 1.27 mm (hardened steel).
- For all prosthetic, healing and locking screws.

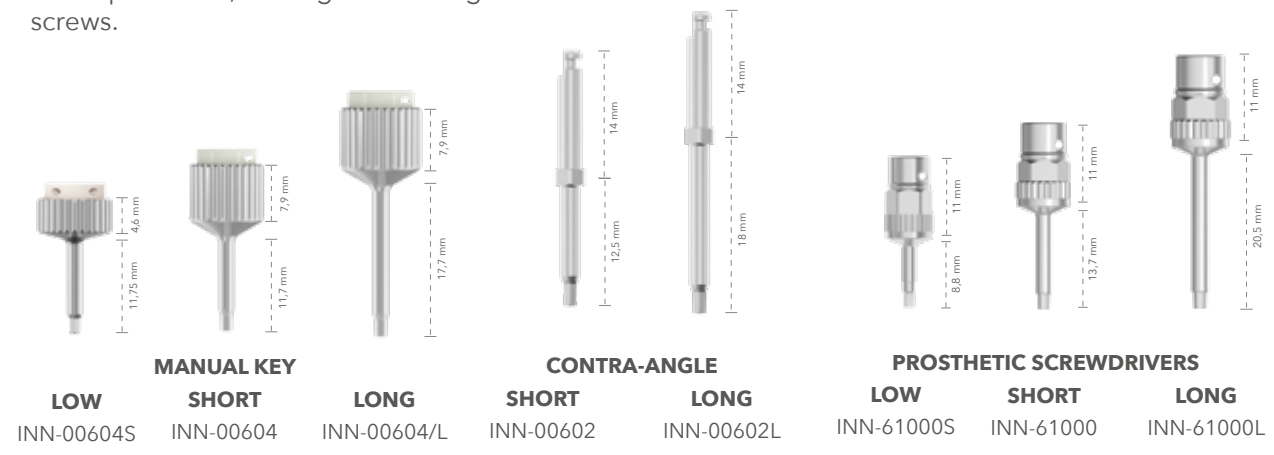

EXTRACTORS

The extraction keys and screw are used to disengage the prosthetic components used for taper coupling from the implant.

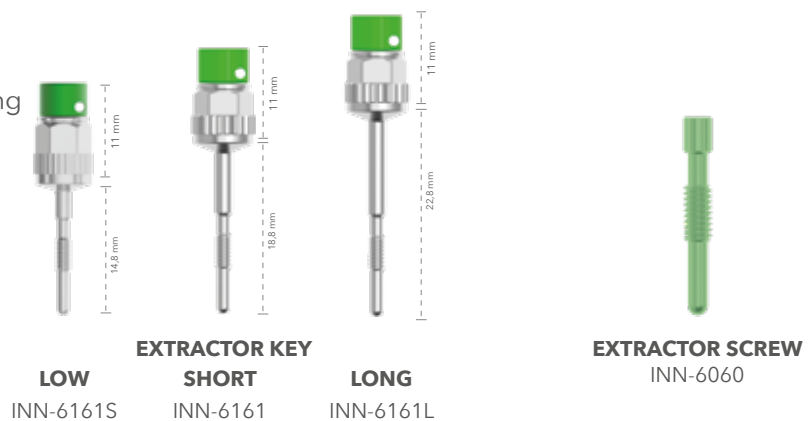

RATCHET & MANUAL KEY

- Finger driver allows to transform the torque ratchet driver into manual driver. It can be used both on implant drivers and on prosthetic screwdrivers.
- The torque ratchet is ideal for the implant insertion and for the fixing of the prosthetic screws. It allows the clinician to accurately apply the recommended preload torque for surgery and prosthetics.



CONICAL DRILLS

- Drills are available in sequential diameters.
- Made of surgical metal with DLC coating, they must be used with external irrigation.
- Drills are identified by colour coding and are laser-marked with the corresponding diameter.
- The grooves on the edges help when preparing the implant site length.
- Presence of 5 laser-marked notches indicating depth.

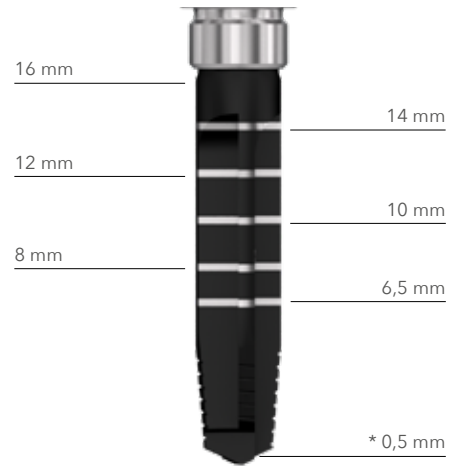

IMPORTANT NOTE
Add 0.5 mm to drill length considering the angled tip.

37 mm							
	Color code	● ø 2,1	● ø 3,0	● ø 3,5	● ø 4,0	● ø 4,5	● ø 5,0
	Actual diameter	ø 2,1	ø 2,6	ø 3,1	ø 3,6	ø 4,1	ø 4,6
	Ref	00074CUT	00075CUT	3P-35CUT	3P-40CUT	3P-45CUT	3P-50CUT**

STANDARD STOPPERS

- Stoppers ensure easy and accurate preparation of implant site depth.
- Laser marking for immediate length identification.
 - Easy and quick to install.

* not included in the kit

Length	04 mm	05 mm	06 mm	07 mm	08 mm	09 mm	10 mm	11 mm	12 mm	13 mm	14 mm	15 mm
Ref	STOP12*	STOP05*	STOP06	STOP11*	STOP01	STOP07	STOP02	STOP08	STOP03	STOP09	STOP04	STOP10*

STOPPERS Ø 5

* not included in the kit

Length	06 mm	07 mm	08 mm	09 mm	10 mm	11 mm	12 mm	13 mm	14 mm	15 mm
Ref	STOP-506*	STOP-511*	STOP-501*	STOP-507*	STOP-502*	STOP-508*	STOP-503*	STOP-509*	STOP-504*	STOP-510*

SHORT CONICAL DRILL

- Drills are available in sequential diameters.
- Made of surgical metal, they must be used with external irrigation.
- Drills are identified by colour coding and are laser-marked with the corresponding diameter.
- The grooves on the edges help when preparing the implant site length.
- Presence of 4 laser-marked notches indicating depth.

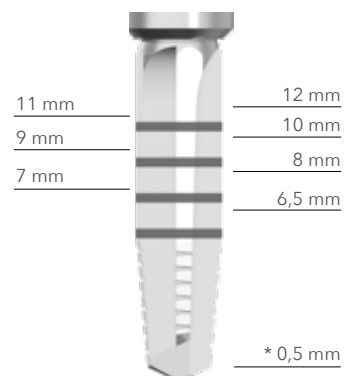

IMPORTANT NOTE

Add 0.5 mm to drill length considering the angled tip.

Reference grooves and laser-marked notches

Color code	● \varnothing 2,1	● \varnothing 3,0	● \varnothing 3,5	● \varnothing 4,0	● \varnothing 4,5	● \varnothing 5,0
Actual diameter	\varnothing 2,1	\varnothing 2,6	\varnothing 3,1	\varnothing 3,6	\varnothing 4,1	\varnothing 4,6
Ref	74SHORT	75SHORT	76SHORT	77SHORT	78SHORT	79SHORT**

STOPPERS FOR SHORT DRILLS

Stoppers ensure easy and accurate preparation of the implant site depth.

- Laser marking for immediate length identification.
- Easy and quick to install.

****NOTE:** stoppers cannot be installed to taper drill \varnothing 5 and on expansion compactor \varnothing 5,0

Length	06 mm	08 mm	10 mm
Ref	STOP-06S	STOP-08S	STOP-10S

COMPACTORS-EXPANDERS

- Compactors-expanders are available in sequential diameters.
- They are made of surgical stainless steel.
- All compactors-expanders are colored and have a laser marking of the implant depth for an easy identification during the surgery.
- The laser lines on compactors-expanders help to prepare the length of the implant site.

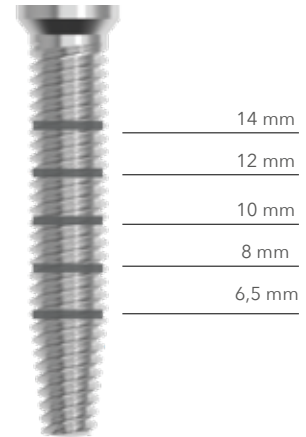

IMPORTANT NOTE

Compactors expanders can be used with stops on page 79.



Color code	\varnothing 2.1	\varnothing 3	\varnothing 3.5	\varnothing 4	\varnothing 4.5	\varnothing 5
Actual diameter	\varnothing 2,0	\varnothing 2,5	\varnothing 3,2	\varnothing 3,7	\varnothing 4,2	\varnothing 4,7
Ref	201-3P	281-3P	331-3P	381-3P	431-3P	481-3P**

****NOTE:** stoppers cannot be installed to taper drill \varnothing 5 and on expansion compactor \varnothing 5,0

COUNTERSINK DRILLS

Used in case of hard bone, to prepare cortical neck for implant placement, widening the crestal area of implant site.





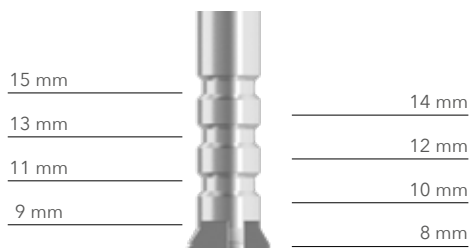

	\varnothing 3,0/3,4	\varnothing 3,5/4,0	\varnothing 4,5/5,0
Actual diameter	\varnothing 3,0/3,4	\varnothing 3,5/4,0	\varnothing 4,5/5,0
Ref	NECK-334	NECK-354	NECK-455



BONE TAPS

Screw taps are used to prepare implant site threaded profile, so as to reduce pressure on the bone. Tapping must be carried out with a ratchet and as the last step before implant placement.

					
Color code	ø 3	ø 3.5	ø 4	ø 4.5	ø 5
Actual diameter	ø 3,0	ø 3,5	ø 4,0	ø 4,5	ø 5,0
Ref	TAP-30	TAP-35	TAP-40	TAP-45	TAP-50

REAMERS

In case of excessive growth of bone onto the implant, the bone reamer allows excess removal to help insertion of prosthetic and surgical components.

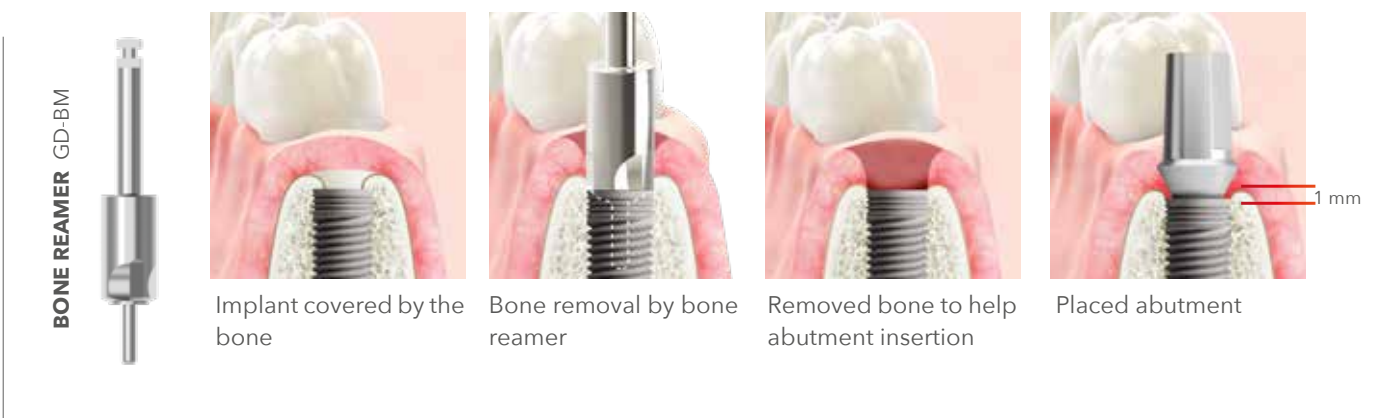

IMPLANT PLACEMENT

In order to obtain the best possible results from the healing process, it is important to place the implant 1 or 1.5 mm below the crestal level and never above it. B&B Dental implants have been designed and treated to allow the perimetral bone to carry out proliferation and osseointegration also along the implant neck, thereby lending long-term stability to the implant. Implant surface is fully mordanted on the outside to offer a valid support on which the bone can proliferate, thus promoting osseointegration. This type of placement together

with abutment design realise the so-called "platform switching" concept whose effectiveness has been widely recognised by literature as well as its key importance for implant rehabilitation positive results in the long term, in terms of stability and aesthetics.

Stop length is equal to the implant length or higher by a millimetre in order to help implant placement and an easier osteotomy preparation. If required, it is also possible not to use the stops, and instead pay attention to the laser marks on the drills for preparation.

WIDE CONICAL DRILLS

- Drills are available in sequential diameters.
- Made from surgical metal, they must be used with external irrigation.
- Drills are identified by colour coding and are laser-marked with the corresponding diameter.
- The grooves on the edges help when preparing the implant site length.
- Presence of 4 laser-marked notches indicating depth.

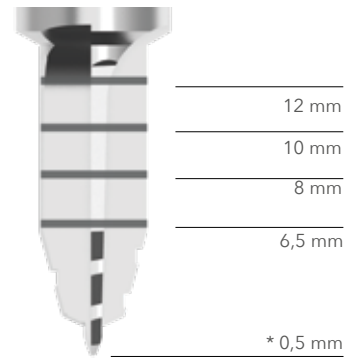

IMPORTANT NOTE

Add 0.5 mm to drill length considering the angled tip.

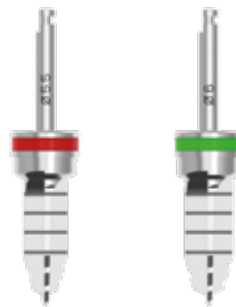

Color code	● $\varnothing 5.5$	● $\varnothing 6$
Actual diameter	$\varnothing 5,0$	$\varnothing 5,5$
Ref	WIDE-55CUT	WIDE-60CUT

WIDE STOPPERS

Wide stops ensure easy and accurate preparation of the implant site depth.

- Laser marking for immediate length identification.
- Easy and quick to install.



Length	06 mm	08 mm	10 mm	12 mm
Ref	W-STOP06	W-STOP08	W-STOP10	W-STOP12

MOUNTERS FOR 3P, EV, WIDE IMPLANTS

- Hardened steel drivers to finally drive 3P, EV and WIDE implants.
- Driver external hexagon is aligned with the internal hexagon. During implant insertion and final placing, this allows you to immediately obtain proper positioning of angled abutments.

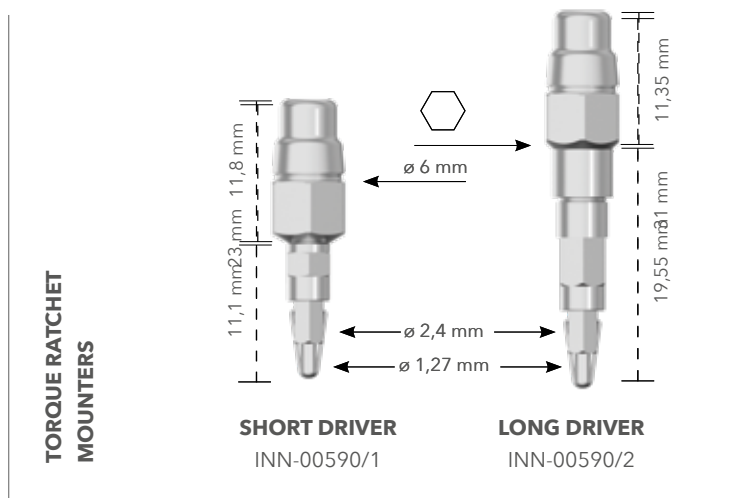

TIGHTENING:

Maximum rightening 70 Ncm. Check tightening torques and procedures on pages 11-12.

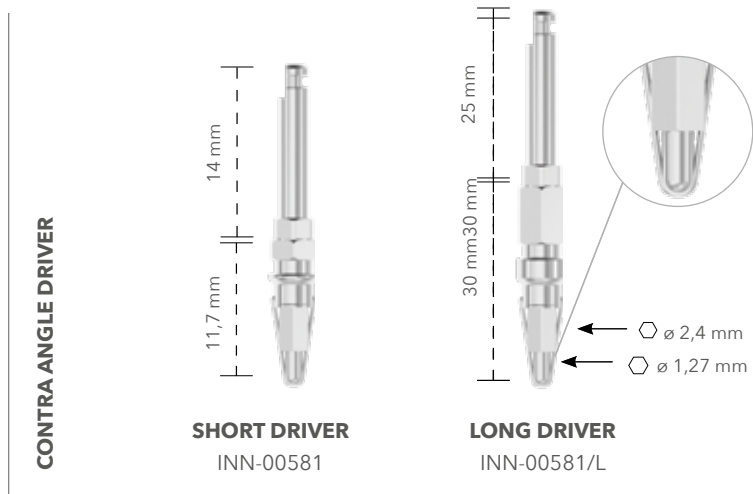

DRIVERS FOR SLIM IMPLANTS

- Hardened steel drivers to finally drive SLIM implants.
- Driver external hexagon is aligned with the internal hexagon. During implant insertion and final placing, this allows you to immediately obtain proper positioning of angled abutments.

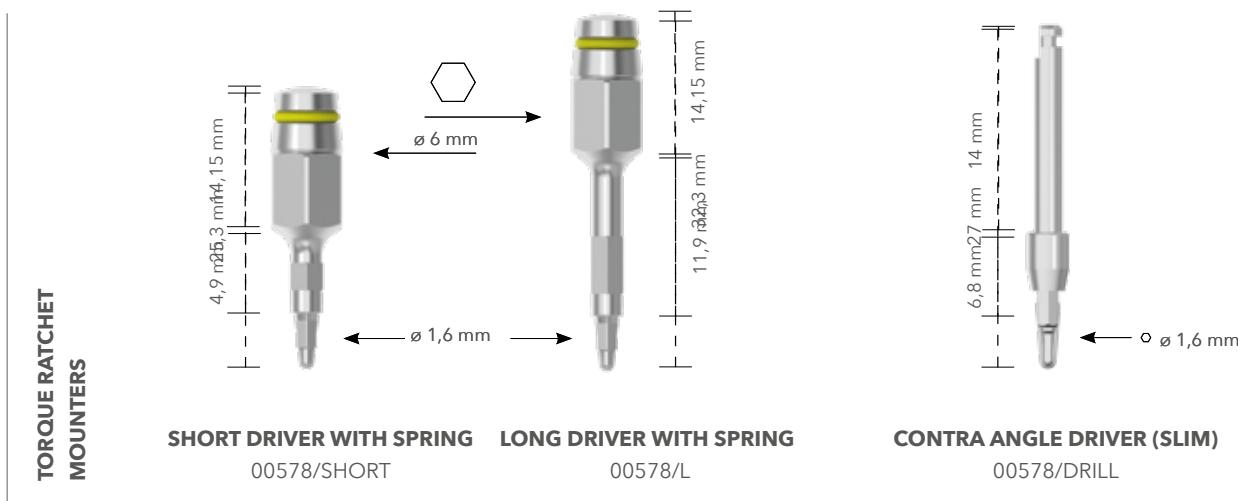

SURGICAL PROTOCOLS

3P DRILLING PROCEDURE

SUITABLE FOR USE IN HARD BONE (D1-D2)

An efficient and atraumatic implant site preparation is created through a procedure relying on a gradual drilling technique. The whole stage of bone tissue drilling must be performed under an abundant external irrigation with saline or, preferably, sterile distilled water. Furthermore, drilling must be intermittent both to avoid bone to heat up and to create a pumping effect that will help effective removal of bone tissue.



SUITABLE FOR USE IN SOFT BONE (D3-D4)

Compactor-expander of the DURA-VIT system are a valid alternative to osteotomes for maxillary expansion and condensation, when preparing the implant site. Expansion compactor are also an alternative to the maxillary sinus elevation procedure using Summers technique. DURA-VIT compactor-expander increase implant clinical success, improving primary stability and maintaining bone density. They are used and mounted on manual driver or straight key, and this reduces the trauma caused by percussion osteotomes.

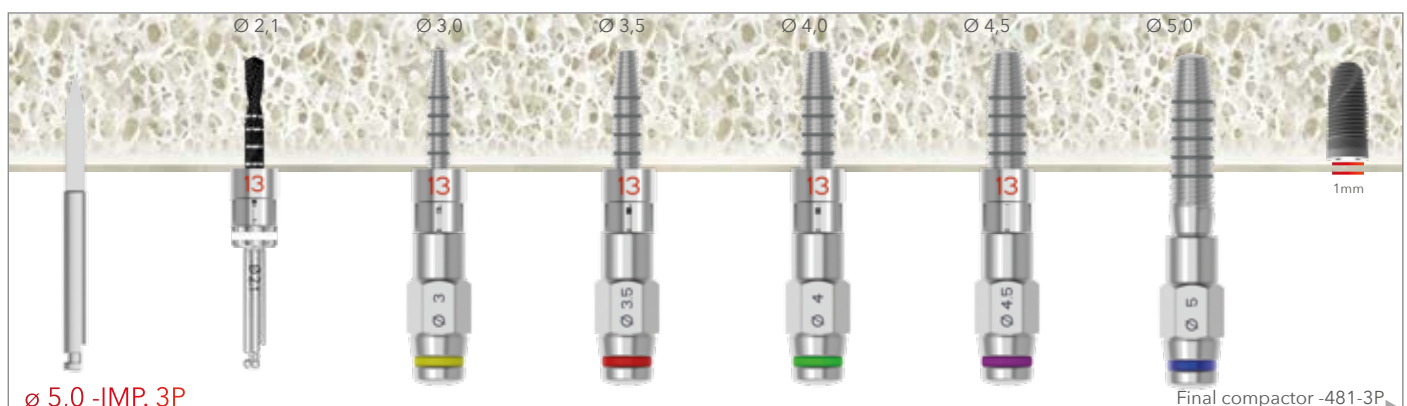
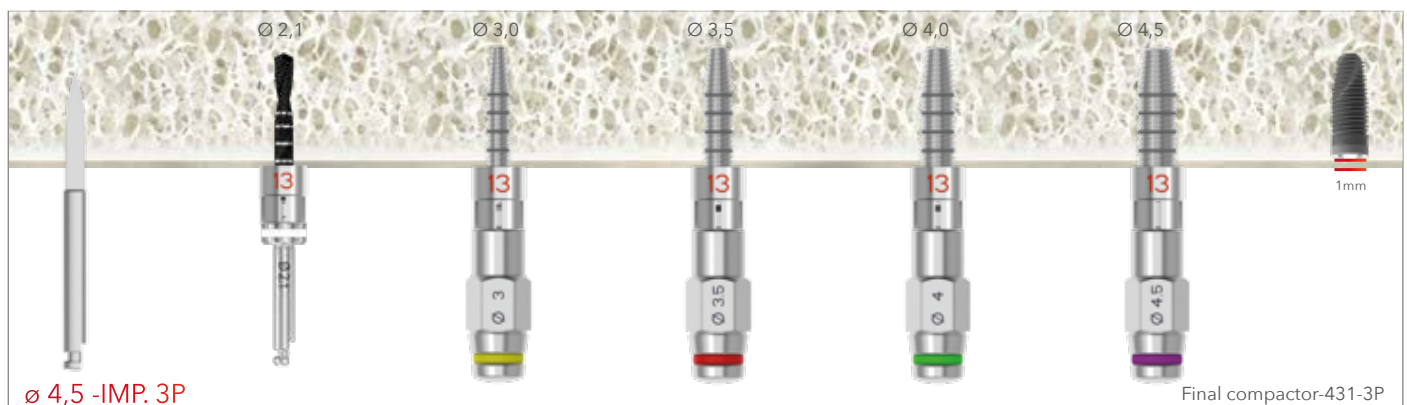

EV DRILLING PROCEDURE

SUITABLE FOR USE IN HARD BONE (D1-D2)

An efficient and atraumatic implant site preparation is created through a procedure relying on a gradual drilling technique. It must be intermittent to avoid bone to heat up.

In case of resistance during placement, turn counter-clockwise by 2-3 turns and carry on with the placement.

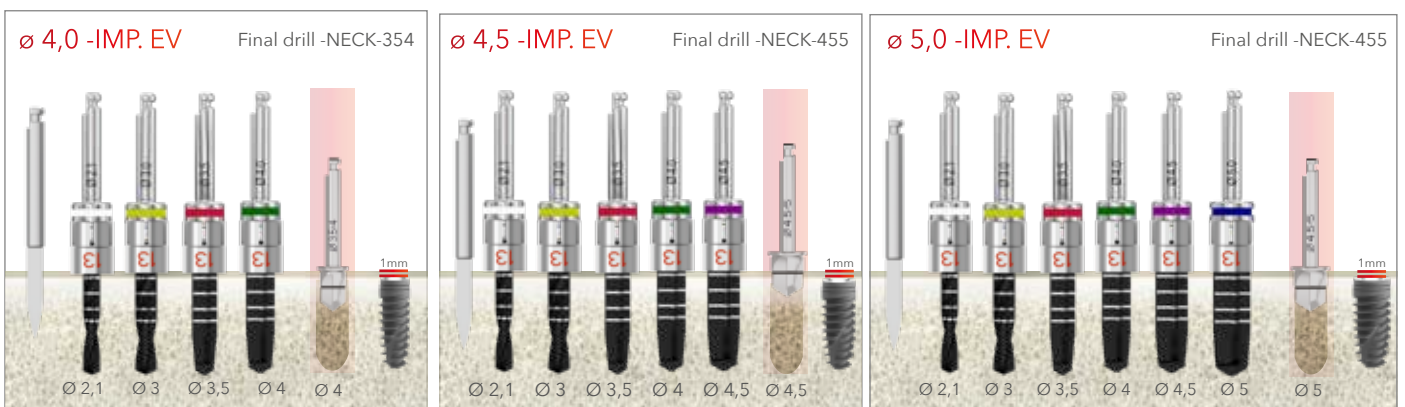

SUITABLE FOR USE IN SOFT BONE (D3-D4)

When bone is soft, the procedure requires the use of compactor-expander of the DURA-VIT system to be able to expand and condense the maxillary sinuses. Compactor-expander increase success rate, improving primary stability and maintaining bone density.

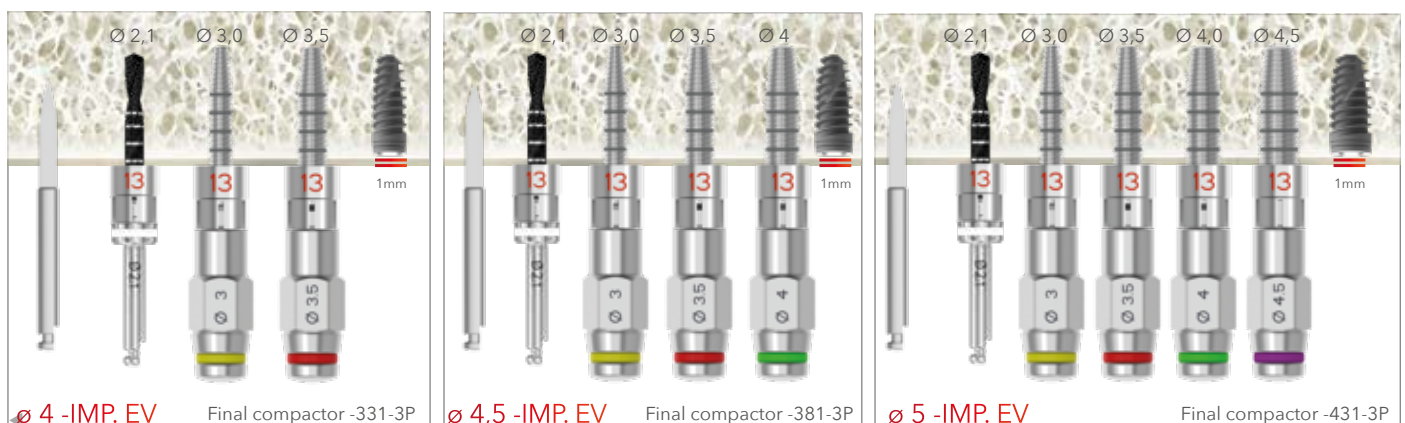

WIDE DRILLING PROCEDURE

SUITABLE FOR USE IN A PREMOLAR AND MOLAR EXTRACTION SITE

Wide implant system has been designed to perfectly adapt to the natural shape of a molar site. In fact, the body of these systems features a larger diameter and a parallel-taper shape that allows easier penetration with a suitable alveolar adaptation. The final result is an immediate and excellent placement of the implant in the extraction site, minimising bone loss and reducing the treatment period.

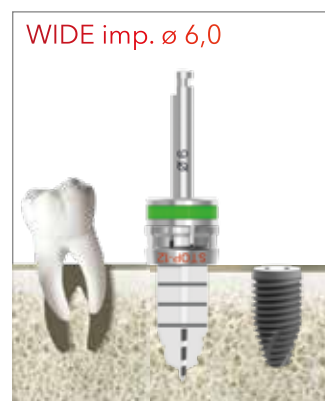

SLIM DRILLING PROCEDURE

SUITABLE FOR USE IN HARD BONE (D1-D2)

SUITABLE FOR USE IN SOFT BONE (D3-D4)



PTERYGO DRILLING PROCEDURE

SUITABLE FOR USE IN HARD BONE (D1-D2)

Pterygo hard bone implants are inserted through a drilling procedure that requires the use of instruments having a gradually increasing diameter, until the implant diameter is obtained. The drills must be directed from the tuber toward the pterygoid fossa.

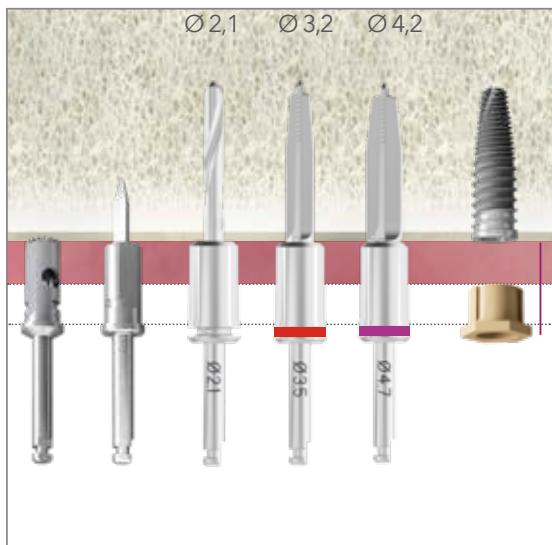

GUIDED



MANUAL

SUITABLE FOR USE IN SPONGY BONE (D3-D4)

When bone is soft, the procedure requires the use of compactors-expanders of the DURA-VIT system to be able to expand and condense the maxillary sinuses. Expansion compactors increase success rate, improving primary stability and maintaining bone density.



GUIDED



MANUAL

MINI IMPLANTS DRILLING PROCEDURE

BALL HEAD



Mark every entry point on patient's tissue using pilot drill 1.5 by bringing it up and down until penetrating the cortical plate.

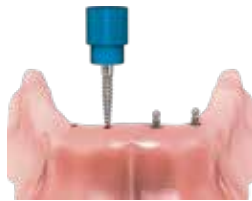

Bring the implant to the site with the plastic assembler and screw it until achieving bone resistance.



Use the wing key to insert the implant. Should this operation be difficult, use the torque ratchet.



The torque ratchet completes implant tightening.



Enlarge the prosthesis to house the metal matrices to be placed on the implants.



Adjust prosthesis height when into patient's mouth using cold resin and asking the patient to apply the pressure of a normal bite in centric occlusion.

SQUARE HEAD



Mark the entry point on patient's tissue using pilot drill 1.5 by bringing it up and down until penetrating the cortical plate.



Bring the implant to the site with the plastic assembler and screw it until achieving bone resistance.



Use the wing key to insert the implant. Should this operation be difficult, use the torque ratchet.



The torque ratchet completes implant tightening.



Prepare temporary and/or final tooth and cement it onto mini implant head.



Rehabilitated case

TRANSCRESTAL SINUS LIFT PROCEDURE

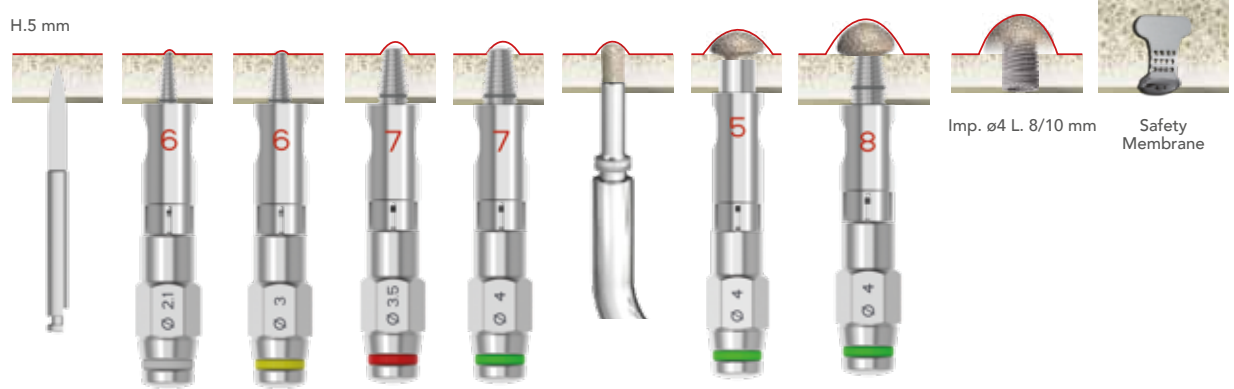

SURGICAL KIT COMPONENTS

PUSH SCREW

- It prepares the bone cavity for implant placement.

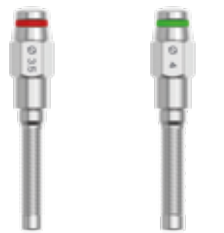

SL-PS35 ø 3,5 SL-PS40 ø 4

PUSH PIN

- It pushes the regeneration material inside the bone cavity.



SL-PP35 ø 3,5 SL-PP40 ø 4

SMARTPEG OSSTELL

B&B DENTAL IS NOW PRESENT WITHIN THE CATALOGUE OF OSSTELL DEVICES FOR MEASURING IMPLANT STABILITY.

B&B DENTAL features suitable SmartPegs to be used together with Osstell IDx and Osstell ISQ measurement equipment. These are devices measuring the resonance frequency of the disposable SmartPeg that is inserted in the implant.



Ref.	implant mod.	SmartPeg type
100404	Slim	22
100425	3P -EV -WIDE	26

PHYSIO BRUSHLESS 3000

PHYSIO BRUSHLESS 3000 is the outcome of a 10-year experience in designing and manufacturing electromedical equipment for dental implantology and endodontics. This proven and well-tried technology offers high performance and extremely simple application. It is also equipped with a new-design pedal which is an absolutely new feature.

CHARACTERISTICS

- Min/MAX speed: 3 to 12,500 RPM
- 6 gearing up and down ratios (1:5, 1:1, 16:1, 20:1, 64:1, 70:1).
- 5 memories.
- 24 torque values. MAX value indicates the maximum torque with no limitation.
- 3 pump settings: 60, 80, 110 ml/min.

PHYSIOBRUSHLESS3000



THE CONTRA-ANGLE MUST BE ORDERED SEPARATELY

COMPLETED WITH:

- Central unit.
- Multifunction pedal controls.
- 1 irrigation tube.

1. Program selection.
2. Forward/reverse.
3. Activate the motor with rheostat effect.
4. Turns on peristaltic pump flow.

ACCESSORIES



Protection cap for the sterilization of the micromotor



Power cable



Support rod for physiological solution



CENTRAL UNITY
UCPHYSIO



MOTOR
MOTORE



PEDAL CONTROLLER
PD102



IRRIGATION TUBE*
DE10271346



TRANSPORT CASE
PD106

*DEVICE DISTRIBUTED BY B&B DENTAL

For complete information see the Physio brushless catalogue



COLLAGEN T-BARRIER MEMBRANES



Collagen T-Barrier Membrane is a resorbable membrane made from equine-derived collagen used to protect implant sites. It can be easily placed on the site after bone grafting and does not require fixation. The membrane provides a perfect basis for hard and soft tissue healing and creates a favourable environment for bone regeneration, as it allows osteogenic-cell growth in the site and avoids unwanted cell migration. It can also be used as a local haemostat. T-Barrier Collagen also has the ability to act as a balanced barrier with controlled resorption, so as to avoid any inflammatory reaction in soft tissue.

T-Barrier Collagen is available in a wide range of sizes:

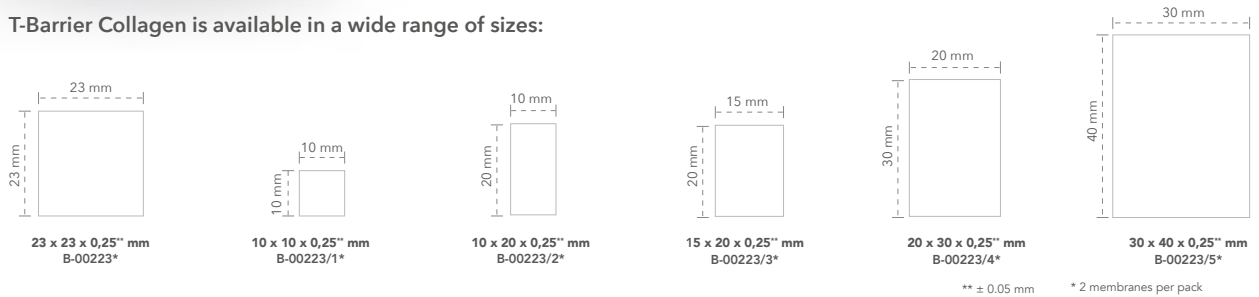

TITANIUM T-BARRIER MEMBRANES

Titanium T-Barrier membranes are titanium grids that are fixed to the implant with a fixation screw to prevent it from shifting within the sinus. They can also be fixed to the bone with osteosynthesis screws to keep the regeneration materials in place in the site. These grids are easy to mould into a shape that will fit the crestal bone.

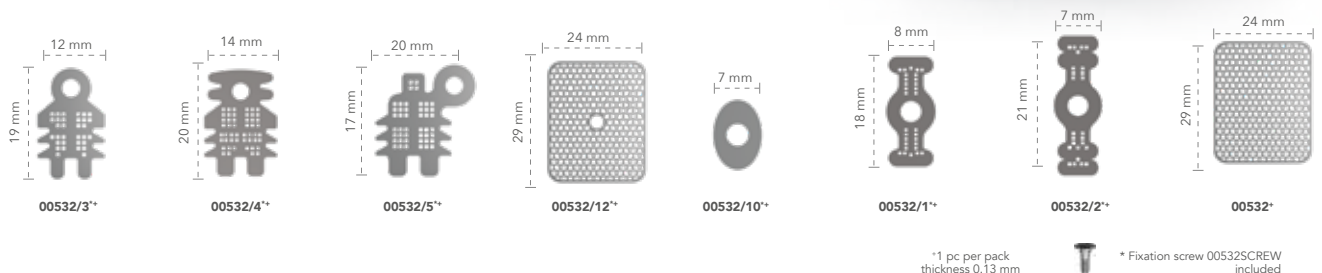

For the whole line consult the regeneration catalogue

05.

DIGITAL WORKFLOW



B&B Dental supports you in integrating new technologies into your workflow, giving you step by step procedures from software to prosthesis thanks to two services: one dedicated to guided surgery and one to the milling center.

You will find a specialised team at your disposal, available to answer all questions, clear your doubts and teach you through internal and on-site courses, as well as a 360-degree service built to adapt to the degree of your knowledge and expectations.



GUIDED SURGICAL KIT

UPPER TRAY

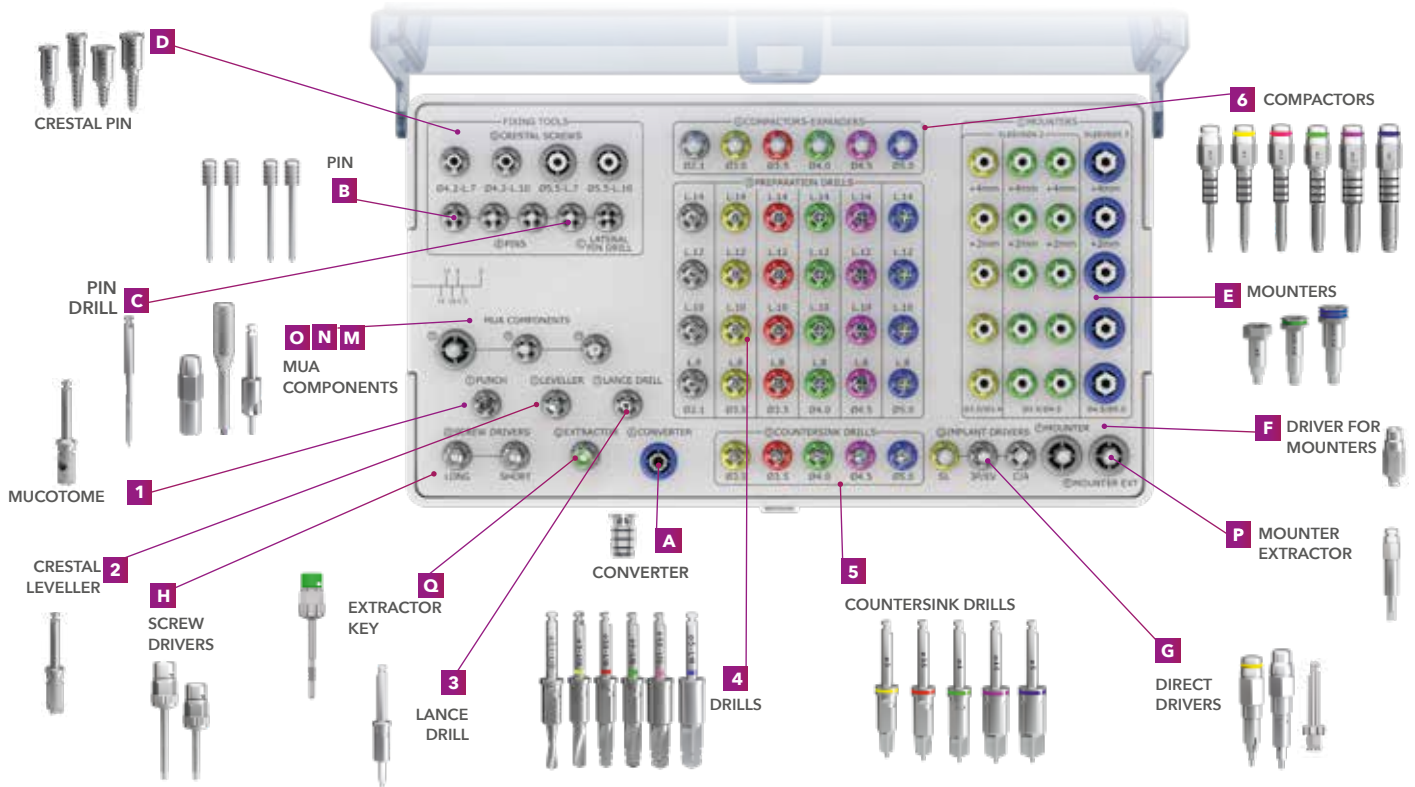

REV. 3D-00093SC

Upper tray

Crestal pin Ø 4,2 H.7	Ref. GD-PIN/57	Drill Ø 2,1 L.10	Ref. GD-21-10
Crestal pin Ø 4,2 H.10	Ref. GD-PIN/510	Drill Ø 2,1 L.12	Ref. GD-21-12
Crestal pin Ø 5,5 H.7	Ref. GD-PIN/67	Drill Ø 2,1 L.14	Ref. GD-21-14
Crestal pin Ø 5,5 H.10	Ref. GD-PIN/610	Drill Ø 3 L.8	Ref. GD-30-08
Pin	Ref. GD-PING	Drill Ø 3 L.10	Ref. GD-30-10
Pin drill	Ref. GD-FOG	Drill Ø 3 L.12	Ref. GD-30-12
Positioner for straight MUA	Ref. INN-00637	Drill Ø 3 L.14	Ref. GD-30-14
Positioner for angled MUA	Ref. 023-MUA	Drill Ø 3,5 L.8	Ref. GD-35-08
Reamer	Ref. GD-BM	Drill Ø 3,5 L.10	Ref. GD-35-10
Mucotome	Ref. GD-263	Drill Ø 3,5 L.12	Ref. GD-35-12
Crestal leveller	Ref. GD-264	Drill Ø 3,5 L.14	Ref. GD-35-14
Screw driver (short)	Ref. INN-61000	Drill Ø 4 L.8	Ref. GD-40-08
Screw driver (long)	Ref. INN-61000L	Drill Ø 4 L.10	Ref. GD-40-10
Extractor key	Ref. INN-6161L	Drill Ø 4 L.12	Ref. GD-40-12
Lance drill	Ref. GD-LANCIA	Drill Ø 4 L.14	Ref. GD-40-14
Converter	Ref. GD-708	Drill Ø 4,5 L.8	Ref. GD-45-08
Drill Ø 2,1 L.8	Ref. GD-21-08	Drill Ø 4,5 L.10	Ref. GD-45-10
		Drill Ø 4,5 L.12	Ref. GD-45-12
		Drill Ø 4,5 L.14	Ref. GD-45-14

LOWER TRAY

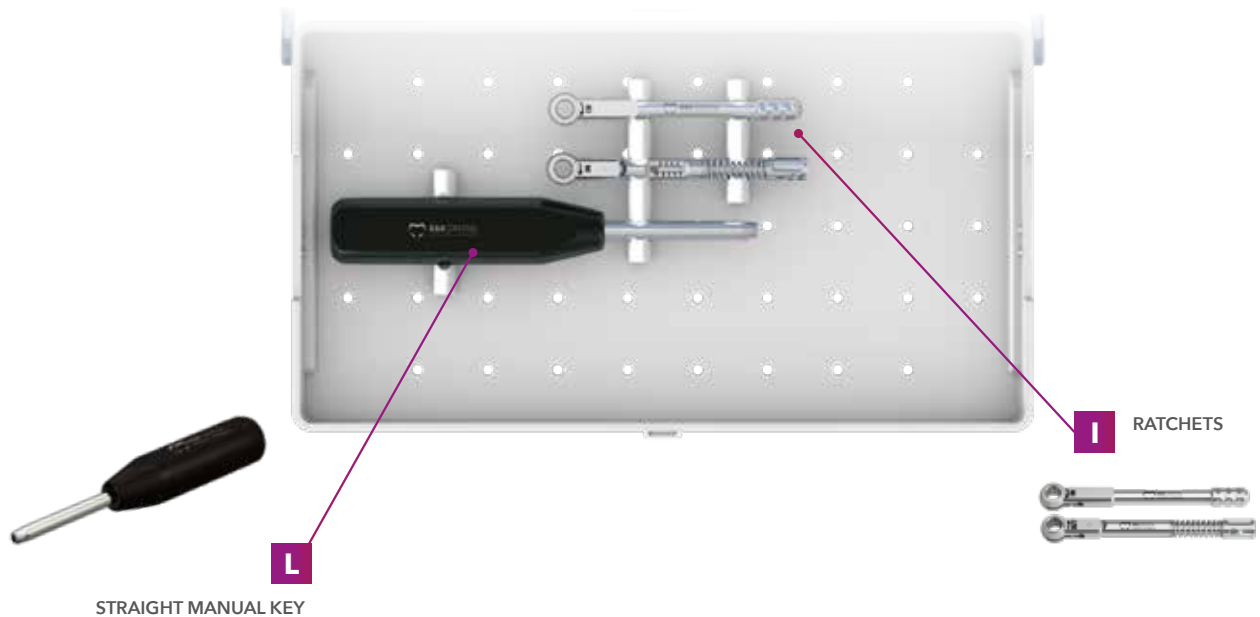

Drill Ø 5 L.8	Ref. GD-50-08	Mounter Ø 3,5-Ø 4 H.+2	Ref. GD-768/12
Drill Ø 5 L.10	Ref. GD-50-10	Mounter Ø 3,5-Ø 4 H.+4	Ref. GD-768/14
Drill Ø 5 L.12	Ref. GD-50-12	Mounter Ø 4,5-Ø 5 H.0	Ref. GD-768/2
Drill Ø 5 L.14	Ref. GD-50-14	Mounter Ø 4,5-Ø 5 H.+2	Ref. GD-768/22
Countersink drill Ø 3	Ref. GD-SV-30	Mounter Ø 4,5-Ø 5 H.+4	Ref. GD-768/24
Countersink drill Ø 3,5	Ref. GD-SV-35	Compactor Ø 2,1	Ref. GD-761/2
Countersink drill Ø 4	Ref. GD-SV-40	Compactor Ø 3	Ref. GD-761/2A
Countersink drill o Ø 4,5	Ref. GD-SV-45	Compactor Ø 3,5	Ref. GD-761/3A
Countersink drill Ø 5	Ref. GD-SV-50	Compactor Ø 4	Ref. GD-761/4A
Guided mounter (SLIM implant)	Ref. GD-00578	Compactor Ø 4,5	Ref. GD-761/5A
Guided implant driver	Ref. GD-701	Compactor Ø 5	Ref. GD-761/6A
Guided direct driver	Ref. GD-00778		
Mounter extractor	Ref. GD-776		
Driver for mounthers	Ref. GD-769	Lower tray	
Mounter Ø 3-Ø 3,4 H.0	Ref. GD-768/3		
Mounter Ø 3-Ø 3,4 H.+2	Ref. GD-768/32	Straight manual key	Ref. 3P-00090CM
Mounter Ø 3-Ø 3,4 H.+4	Ref. GD-768/34	Torque ratchet	Ref. 00376DIN
Mounter Ø 3,5-Ø 4 H.0	Ref. GD-768/1	Ratchet	Ref. 00376



GUIDED KIT OFFSET +2 +4

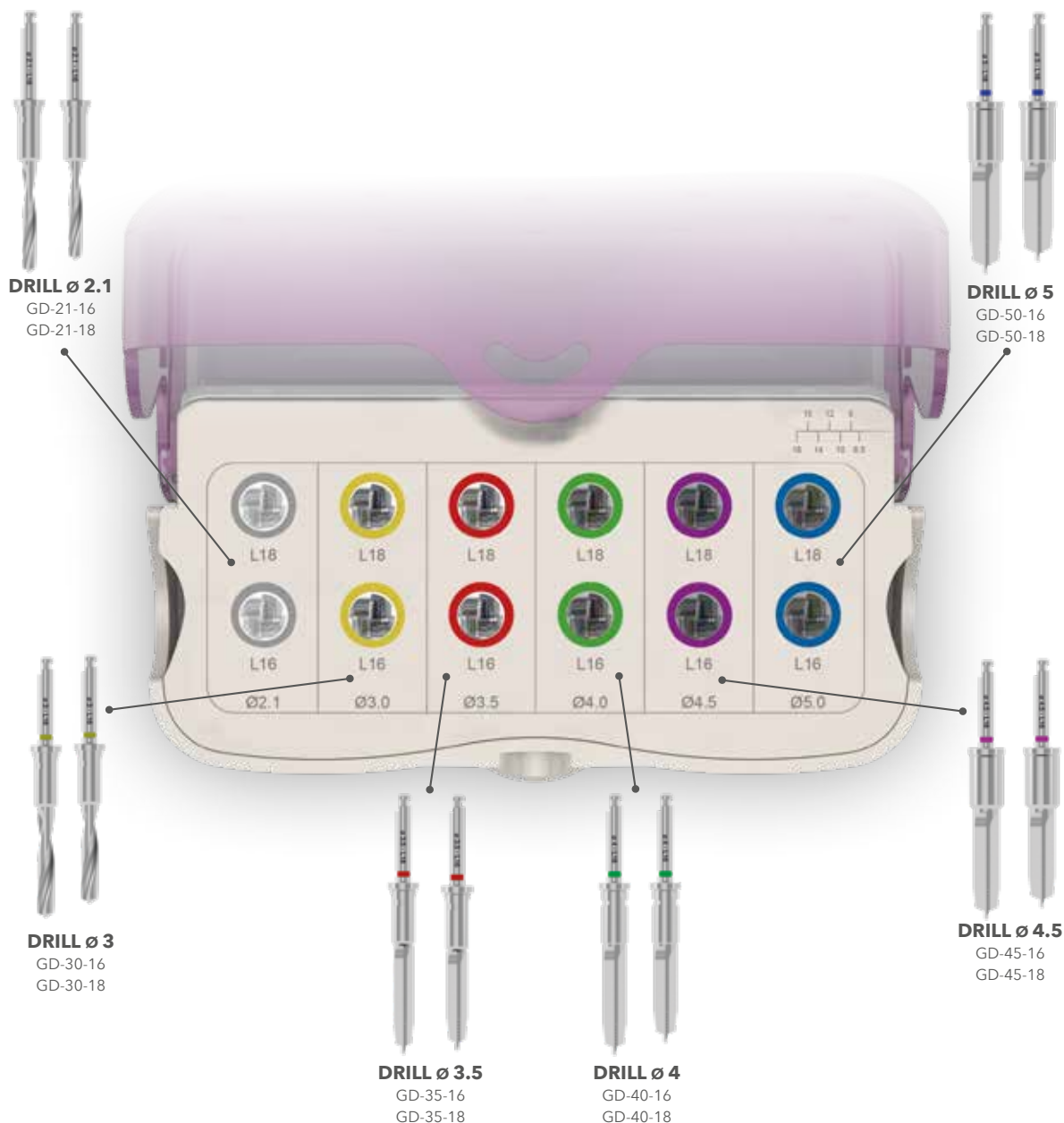

REF. 3D-00093PLUS

Drill Ø 2,1 L. 16mm	Ref. GD-21-16	Drill Ø 4 L. 16mm	Ref. GD-40-16
Drill Ø 2,1 L. 18mm	Ref. GD-21-18	Drill Ø 4 L. 18mm	Ref. GD-40-18
Drill Ø 3 L. 16mm	Ref. GD-30-16	Drill Ø 4,5 L. 16mm	Ref. GD-45-16
Drill Ø 3 L. 18mm	Ref. GD-30-18	Drill Ø 4,5 L. 18mm	Ref. GD-45-18
Drill Ø 3,5 L. 16mm	Ref. GD-35-16	Drill Ø 5 L. 16mm	Ref. GD-50-16
Drill Ø 3,5 L. 18mm	Ref. GD-35-18	Drill Ø 5 L. 18mm	Ref. GD-50-18

GUIDED SLEEVES

The guided sleeves can have two dimensions and are presented as cylinders included in the surgical templates. They have the main function of guiding the surgical instruments during the preparation of the implant site by guiding the position and inclination of the drills. The sleeves are generally incorporated into the surgical templates and, if necessary, can be supplied separately.

LATERAL OPENING

It provides an easy access to the operative site

ONE HEIGHT

5 mm in height to ensure a stable and safe guide



TWO DIAMETERS

A guaranteed guide for any implant diameter



HEXAGON

It provides an exact indication of the position of the hexagon implant

SLEEVE Ø 4.2 MM

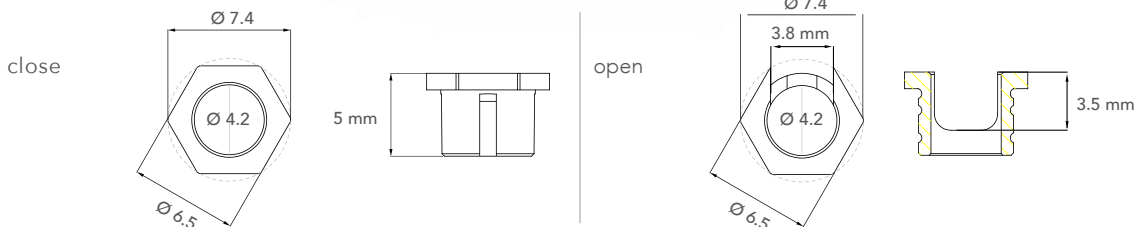

SLEEVE Ø 5.5 MM

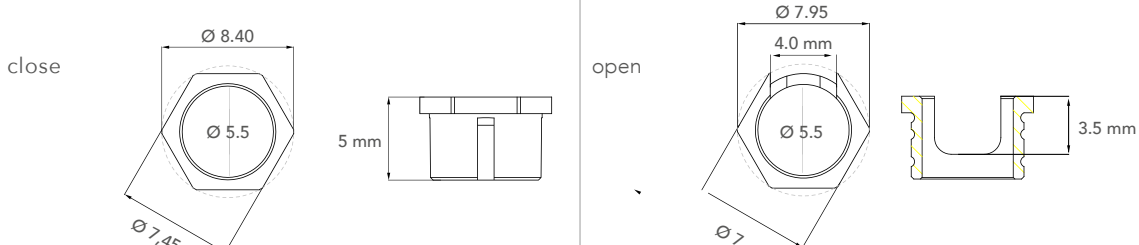

MATCHING WITH RADIOPAQUE MARKERS

In the eventuality of a patient with a total edentulism, in order to allow for the matching of the files derived from the cone beam and of the extraoral and / or intraoral impressions, it is important to place the radiopaque markers forming triangles as shown in the image. In order to guarantee a high degree of precision, the reduced dimensions of the B&B Dental markers allow for easy image acquisition in the cone beam, thereby avoiding problems of falsification or incomplete acquisition (especially with large markers) in the case of a cone beam with an insufficient field of view (FOV).



GD-SFERE
1 cf x 5 pcs



4.2 MM Ø SLEEVE

The drills are to be used successively in order to prepare the implant site to a size suitable for the implant to be placed in position. It is important to assess the hardness of the bone as hard bone may need the use of countersink drill to decrease the resistance given by the cortical bone. In cases where the bone is spongy, the use of compactors may be necessary to obtain primary stability.

HARD BONE PROTOCOL

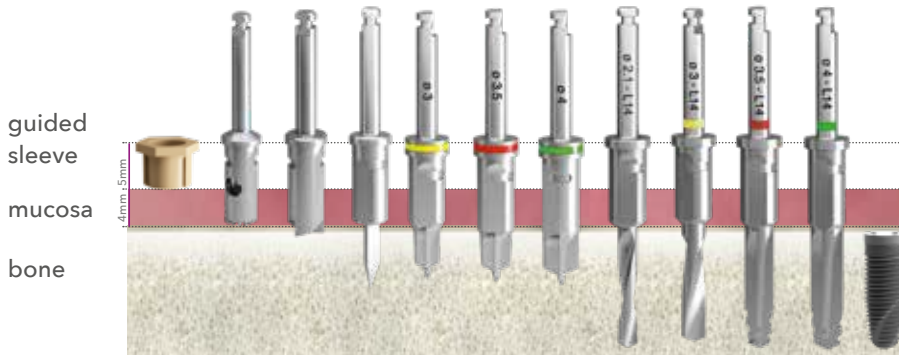

SPONGY BONE PROTOCOL

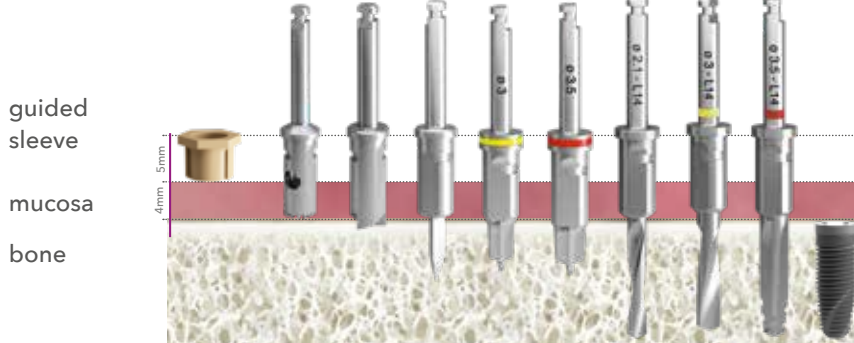

SPONGY BONE PROTOCOL WITH COMPACTORS

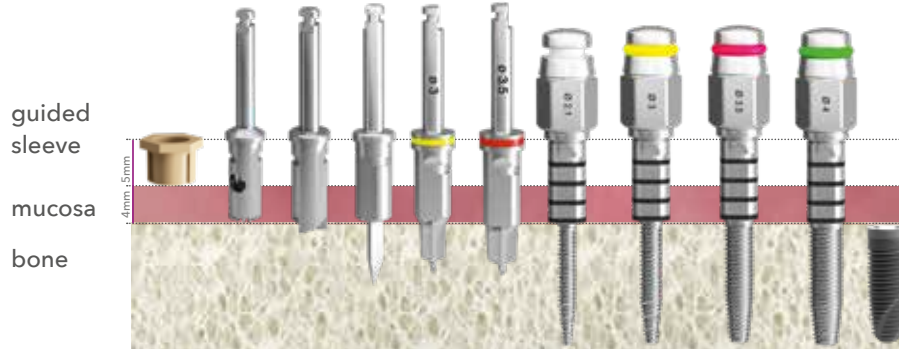

RECOMMENDED SPEED: spongy bone 350 - 600 rpm
 hard bone 800 - 1000 rpm

NOTE

Always bring the drills to the full-travel stop making sure to use the cooling systems to avoid excessive overheating. The drills prepare an osteotomy increased by 0.5 mm compared to the length of the implant.



5.5 MM Ø SLEEVE

The first drills for the preparation of the osteotomy with 5.5 mm sleeves diameter must be coupled to the converter, allowing for a guided insertion into the sleeve. Larger diameter drills are already prepared with a neck diameter suitable for the wide sleeve.

HARD BONE PROTOCOL

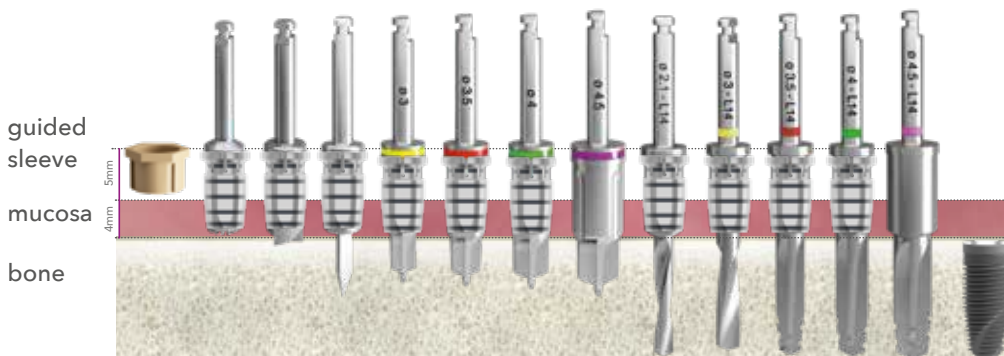

SPONGY BONE PROTOCOL

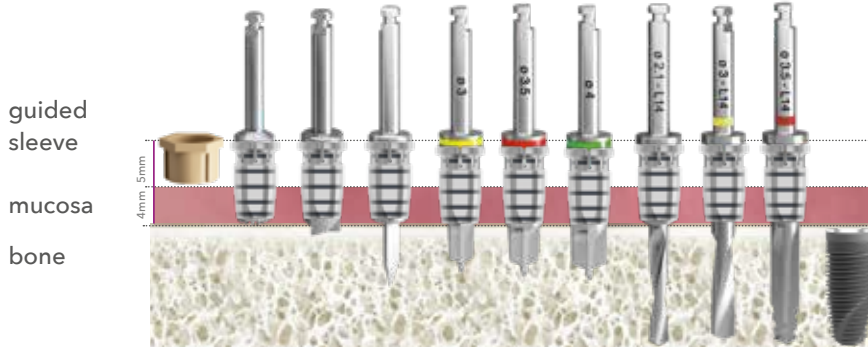

SPONGY BONE PROTOCOL WITH COMPACTORS

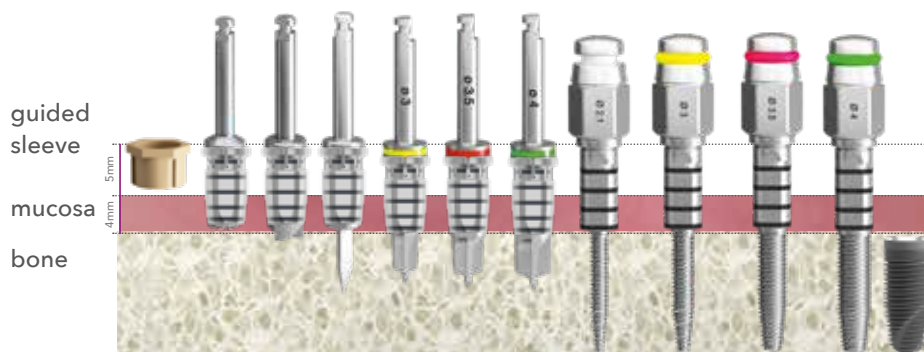

GUIDED SURGERY KITS MINI IMPLANTS LINE



REF. G-1807/1

Torque ratchet (50 NCM)

Ref. 8070.

Surgical drill (short) Ø 1.3mm

Ref. G-1013S

Manual butterfly key

Ref. MD-3002

Surgical drill (short) Ø 2.0mm

Ref. G-1020S

Adapter (short)

Ref. S7007.

Surgical drill (long) Ø 1.1mm

Ref. G-1011L

Adapter (long)

Ref. S7015.

Surgical drill (long) Ø 1.3mm

Ref. G-1013L

Surgical drill (short) Ø 1.1mm

Ref. G-1011S

Surgical drill (long) Ø 2.0mm

Ref. G-1020L

GUIDED SURGERY DRILLS KIT MINI IMPLANTS LINE



REF. G-1807XS.

Surgical drill (short) Ø 1.1mm

Surgical drill (short) Ø 1.3mm

Surgical drill (short) Ø 2.0mm

Surgical drill (long) Ø 1.1mm

Surgical drill (long) Ø 1.3mm

Surgical drill (long) Ø 2.0mm

GUIDED SURGICAL PROTOCOL MINI IMPLANT

The MDI guided surgery system is made of 2 sets of 3 drills each. Long and short drills in the diameters of 1,1mm 1,3mm and 2mm. This allows the user to have guidance and follow the standard MDI protocol of under preparation of the site with a drill diameter that is less than the diameter of the implant as well as making an osteotomy that is 1/3 the total length of the implant. In the case of hard bone the user has the possibility of drilling deeper or wider through using the same sleeve guidance.

Please note: That by following the standard protocol the system provides for directional guidance but is not able to provide full depth and placement guidance for implant

SURGICAL PROTOCOL FOR GUIDED MINI IMPLANT DIAMETER Ø 1.8 mm - drills ø 1.1 mm

SHORT DRILLS

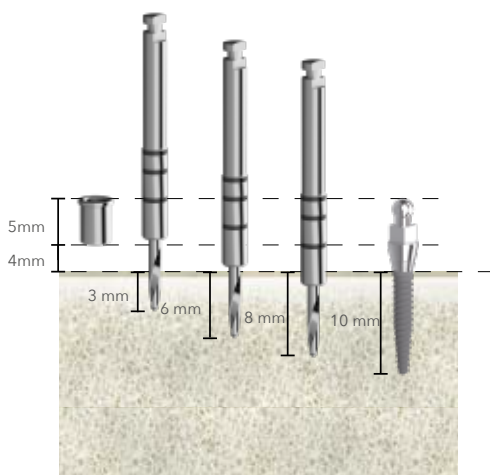

LONG DRILLS

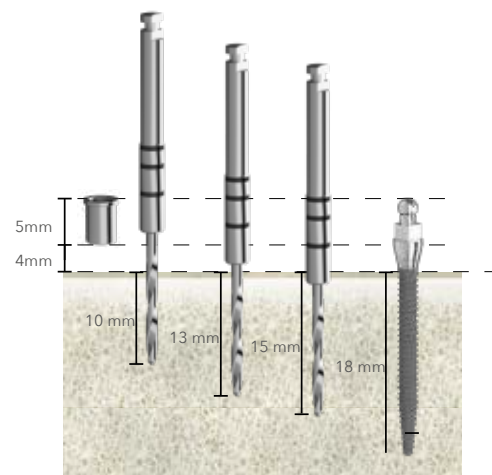

SURGICAL PROTOCOL FOR GUIDED MINI IMPLANT DIAMETER Ø 2.1 mm - drills ø 1.3 mm

SHORT DRILLS

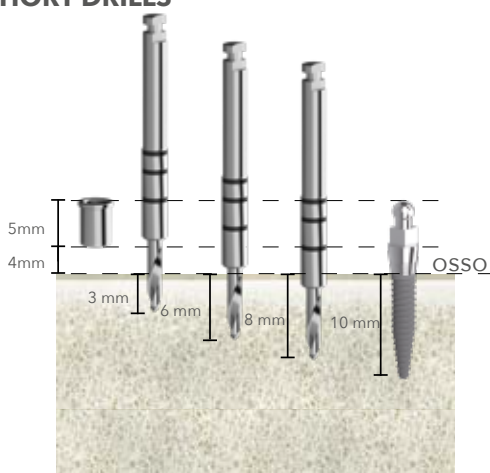

LONG DRILLS

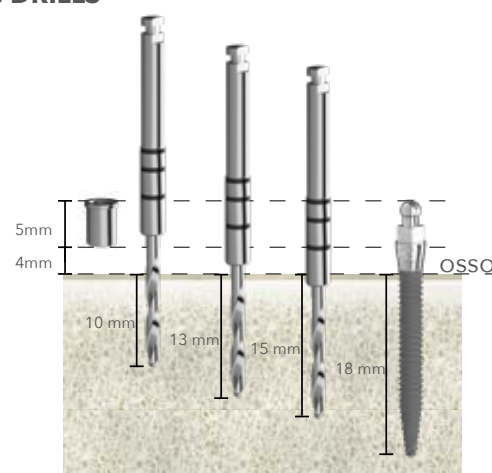

SYNERGY

B&B Dental aims at supporting odontologists in all their projects by providing two valuable support services both in the design of surgical templates and in the construction of prosthetic structures. SYNERGY was born from the union between these

two services; it aims at closing the circle between B&B Dental and your practices and laboratories to enable users of all levels to employ the new technologies thanks to a team of specialised technicians and the right tools.

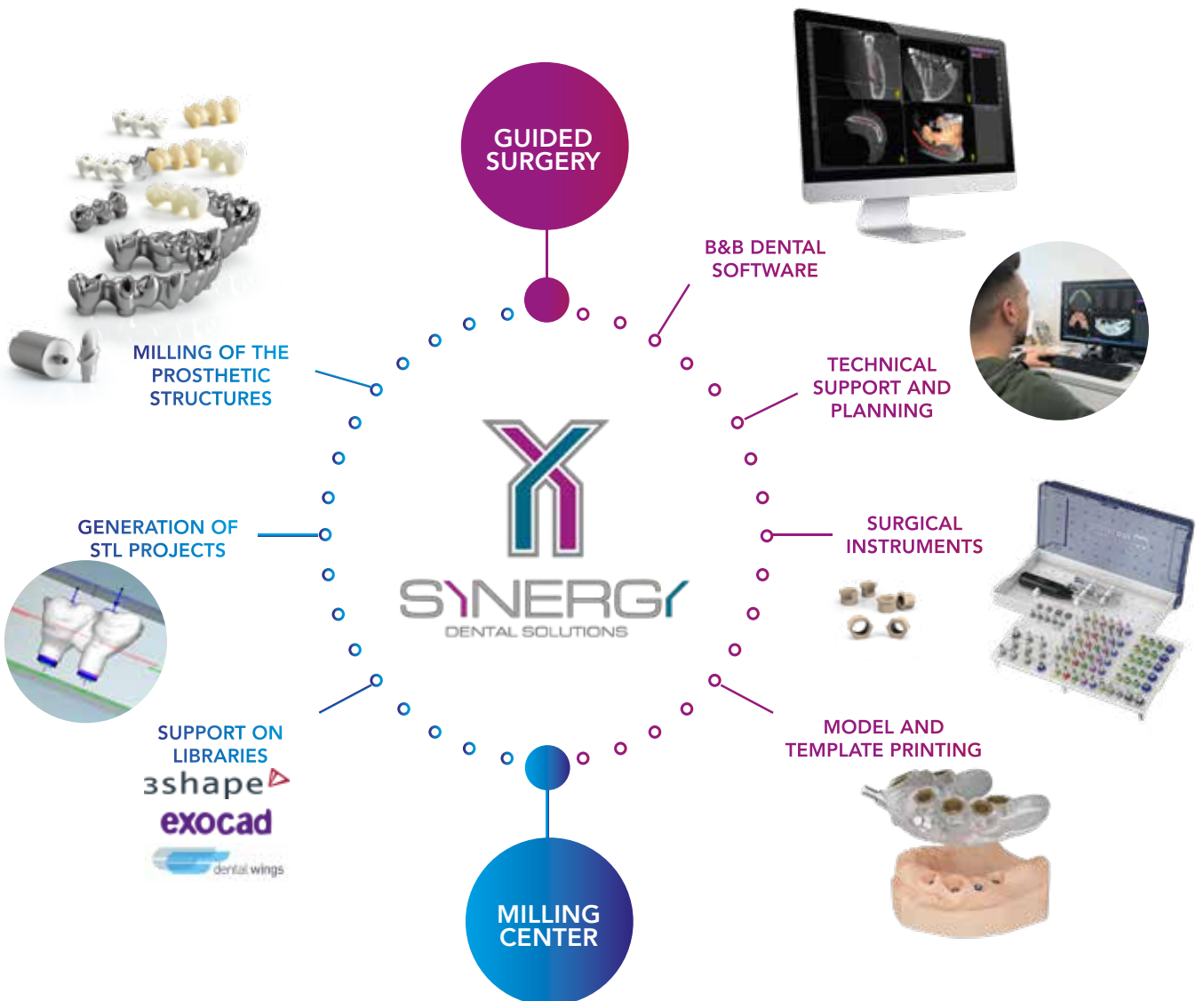

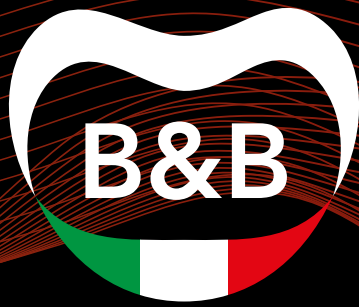

CONTACTS

REGISTERED OFFICE & OPERATIONAL 1:

Via S. Benedetto, 1837
40018 S. Pietro in Casale (BO) Italy

OPERATIONAL HEADQUARTERS 2:

Via Due Ponti, 19
40050 Argelato (BO) Italy

Tel. +39 (0) 51.81.13.75

Fax +39 (0) 51.666.94.00

info@bebdental.it

www.bebdental.it

